

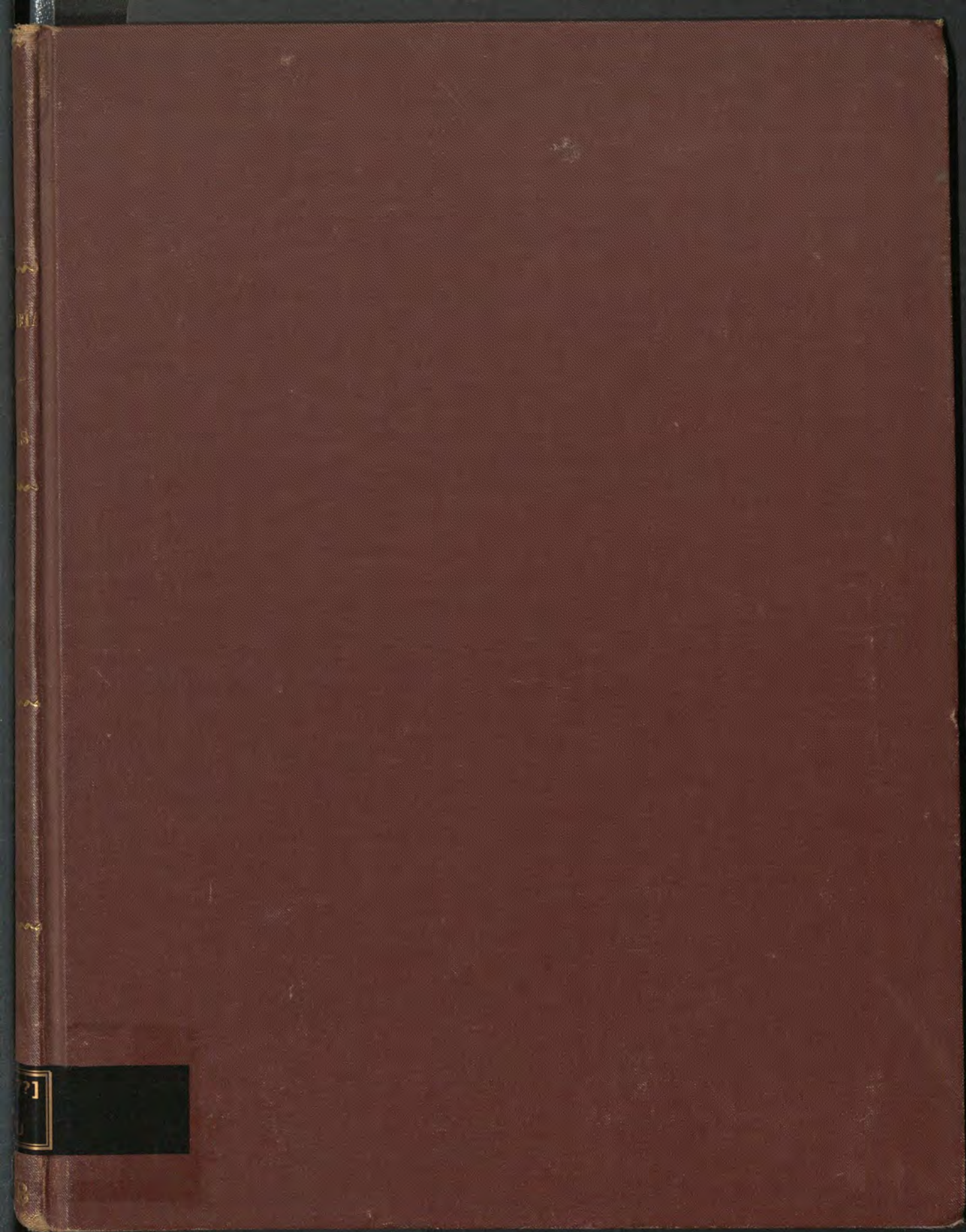
TOPOGRAPHIE

ATLAS

1887?

APU

LIB



FA-466

528.4 (02)  
ECCCP.

1859

R.466

1887-? APU



Fig.<sup>a</sup> 1.<sup>a</sup>

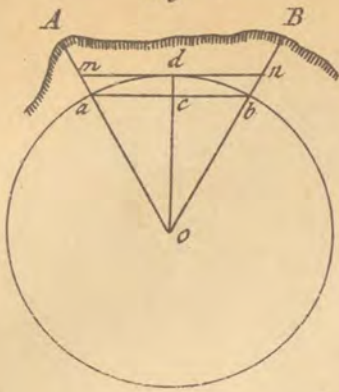


Fig.<sup>a</sup> 2.

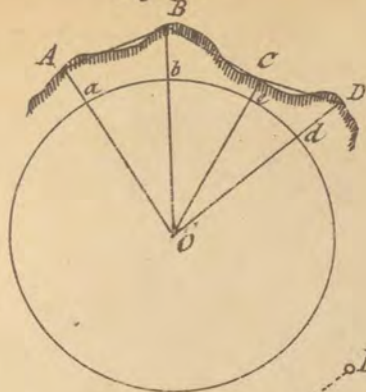


Fig.<sup>a</sup> 3.

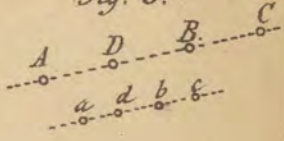


Fig.<sup>a</sup> 4

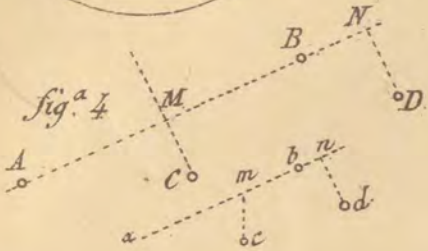


Fig.<sup>a</sup> 5.

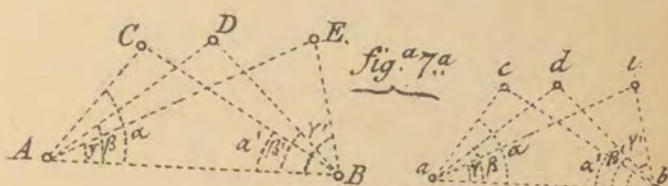
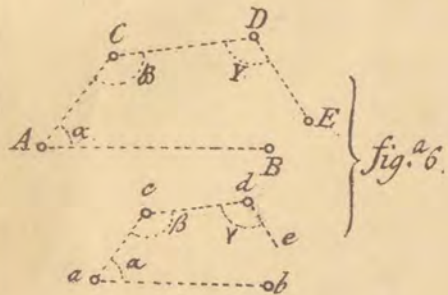
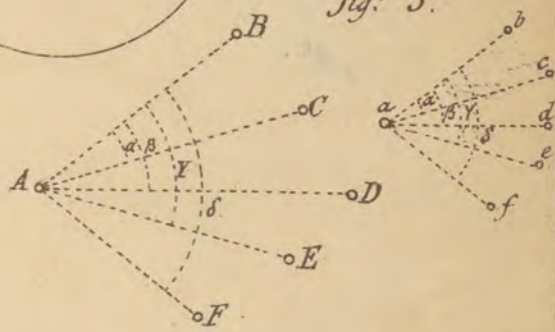


Fig.<sup>a</sup> 7a

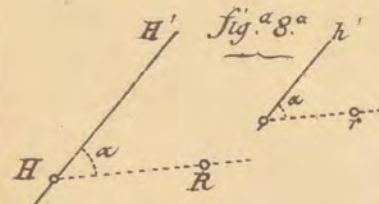


Fig.<sup>a</sup> 8a

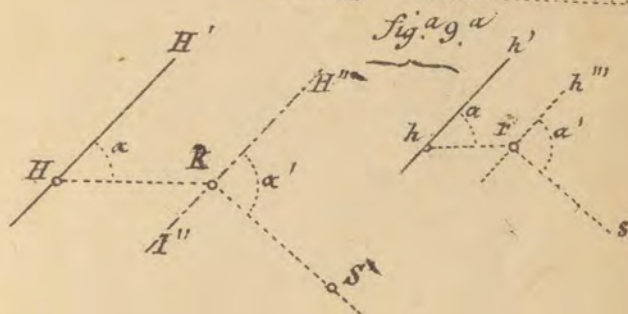


Fig.<sup>a</sup> 9a

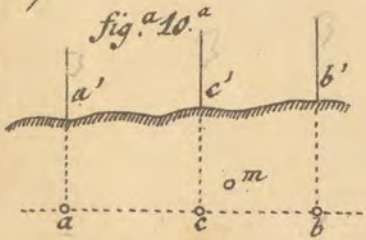


Fig.<sup>a</sup> 10a

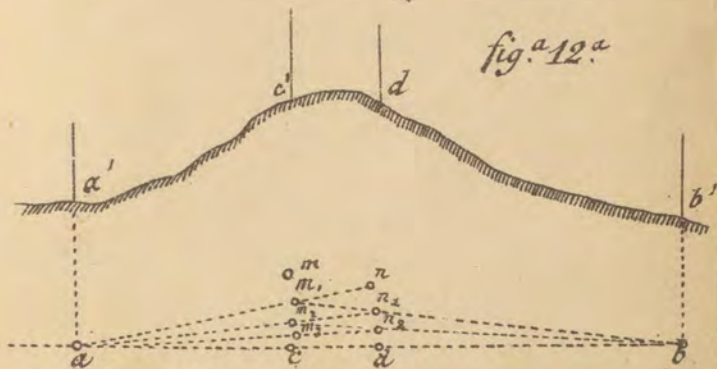


Fig.<sup>a</sup> 12a

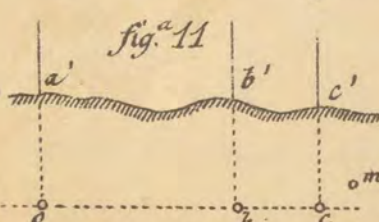


Fig.<sup>a</sup> 11

BIBLIOTECA DEL C. G. A. M.

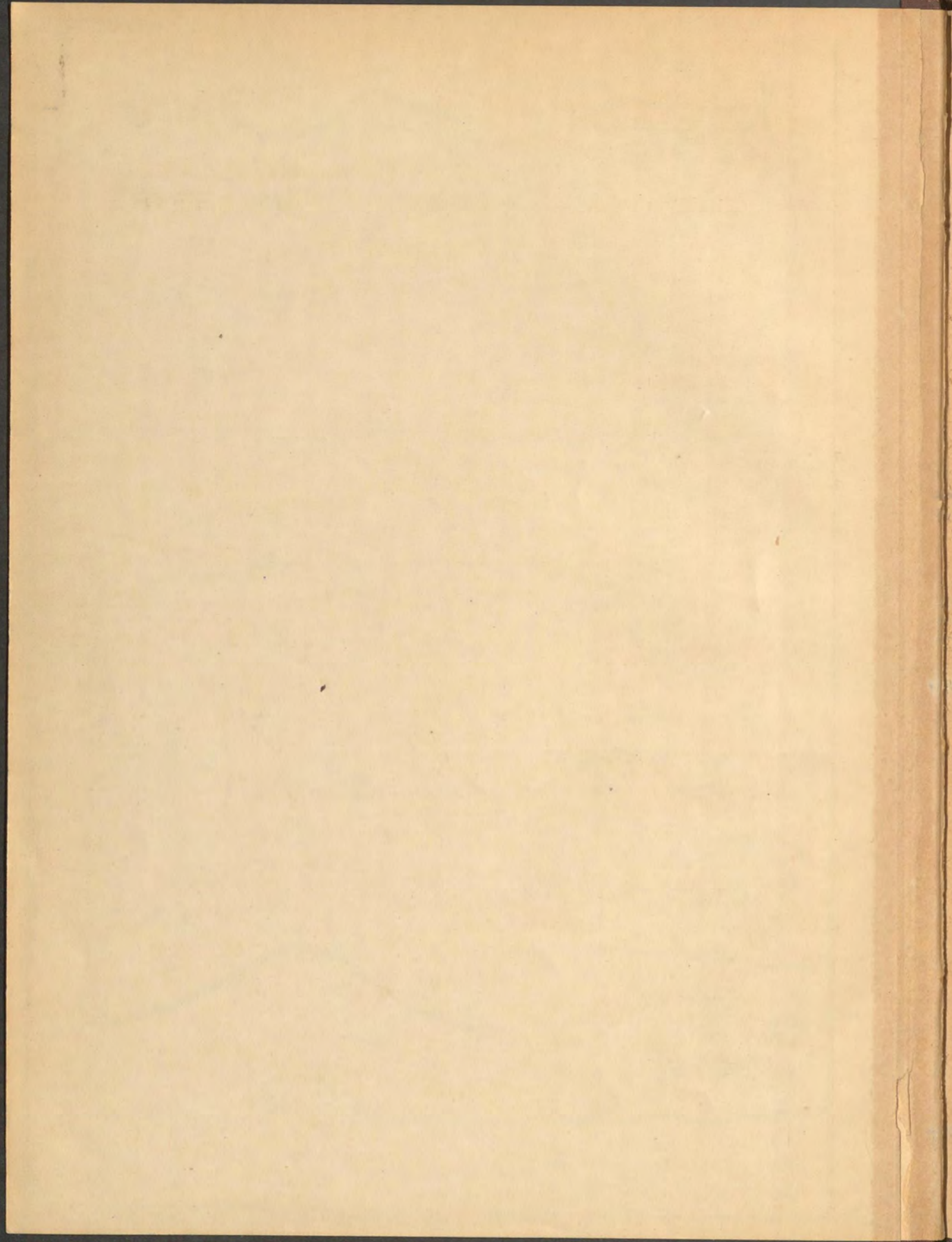


fig.<sup>a</sup> 13.



fig.<sup>a</sup> 14<sup>a</sup>

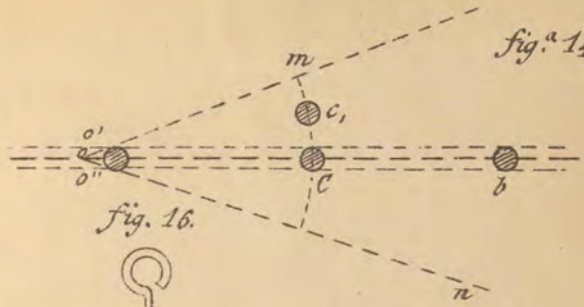


fig. 16.

fig.<sup>a</sup> 17.

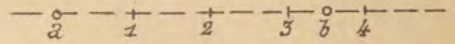


fig.<sup>a</sup> 15.

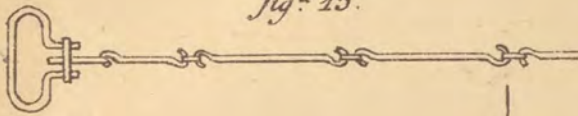


fig.<sup>a</sup> 19.

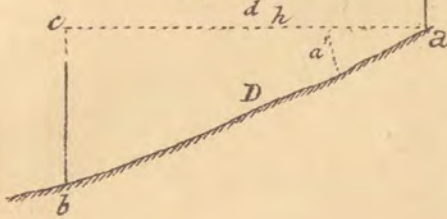


fig.<sup>a</sup> 18.

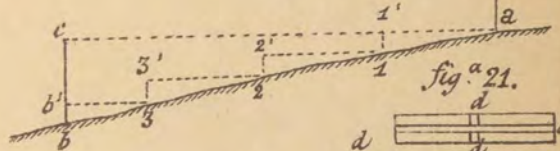


fig.<sup>a</sup> 21.

fig.<sup>a</sup> 23.

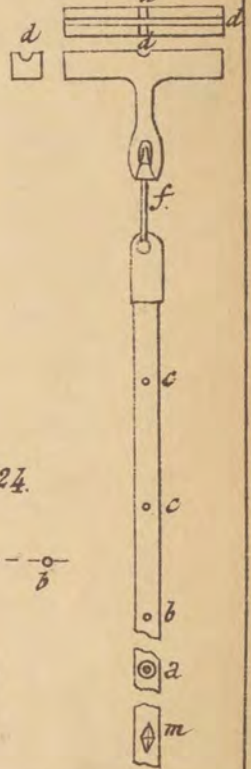
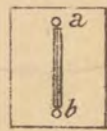


fig.<sup>a</sup> 20.

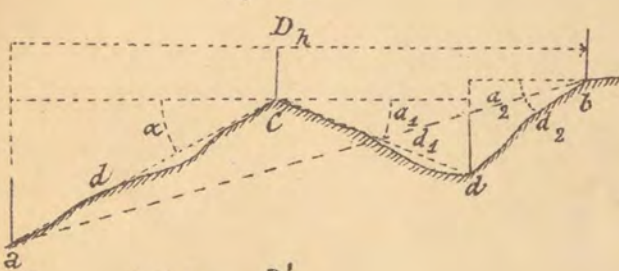


fig.<sup>a</sup> 22.

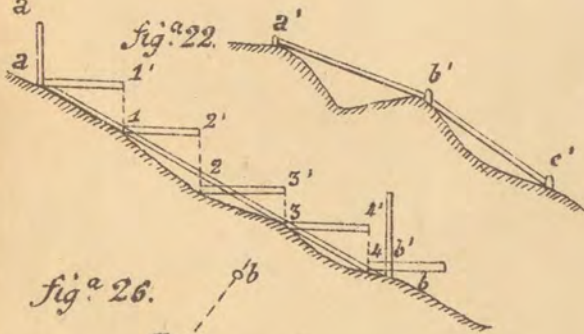


fig.<sup>a</sup> 24.



fig.<sup>a</sup> 25.

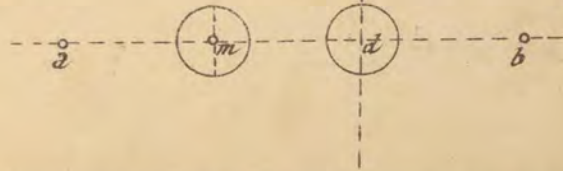
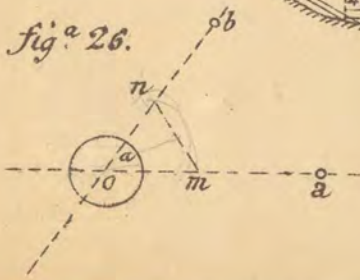
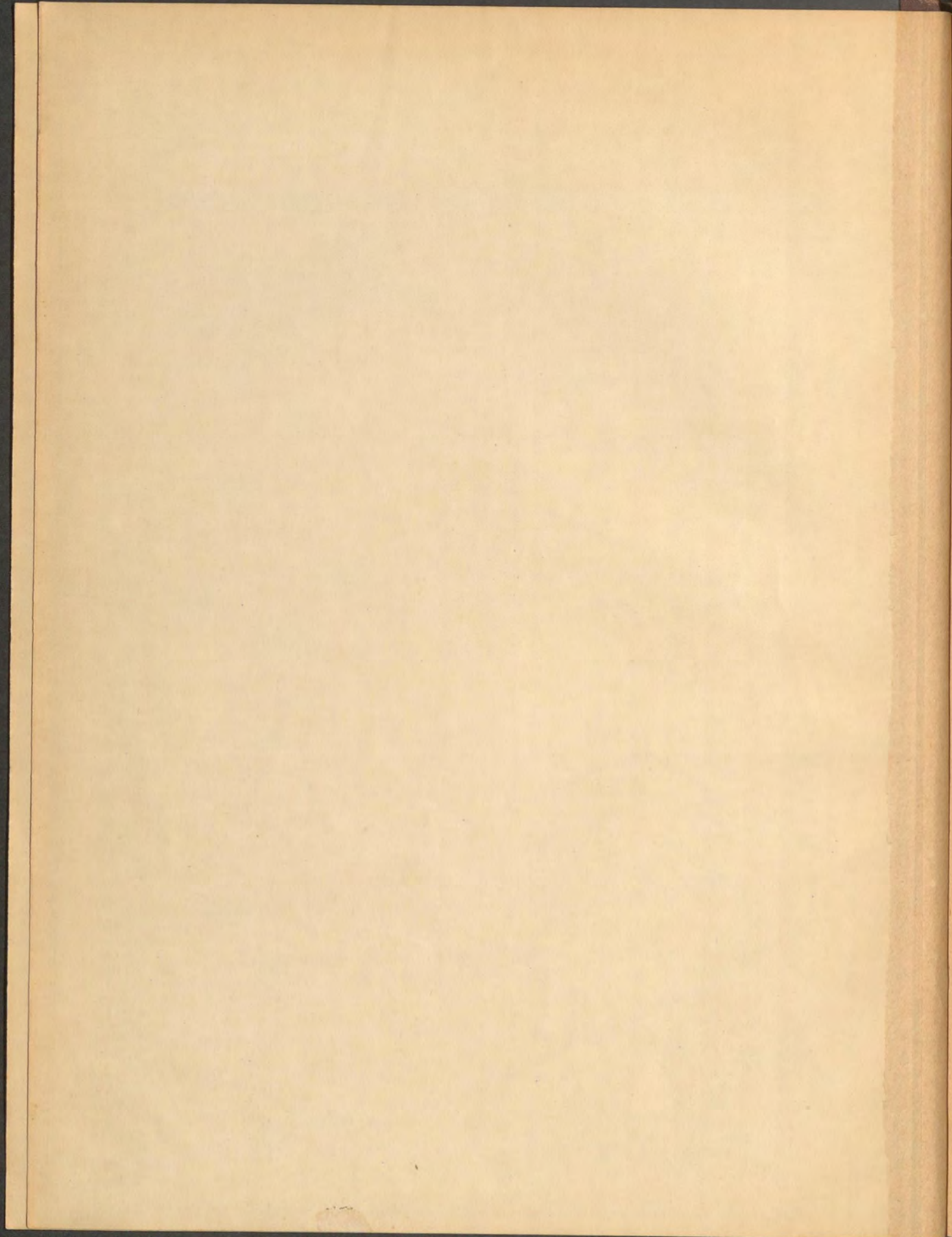
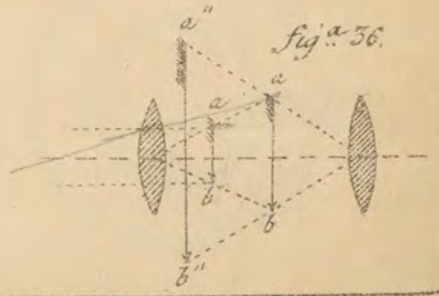
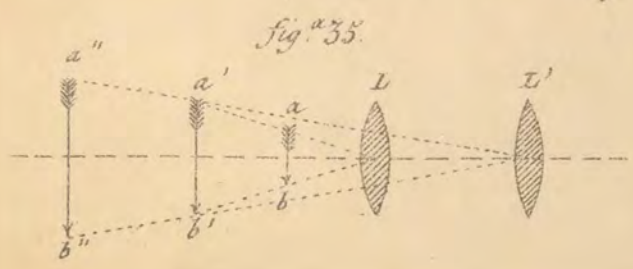
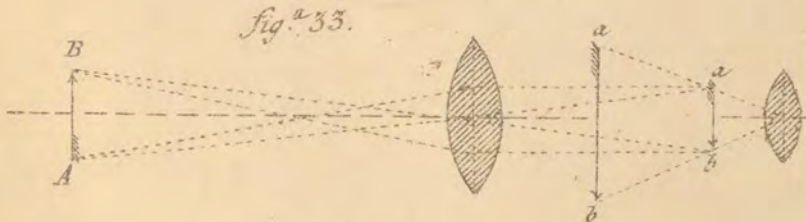
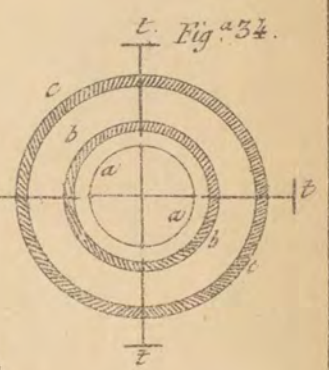
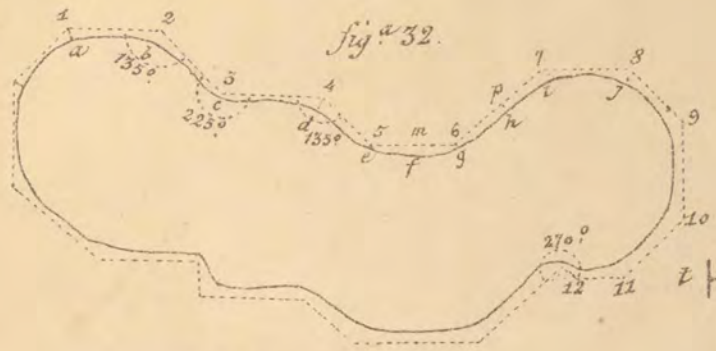
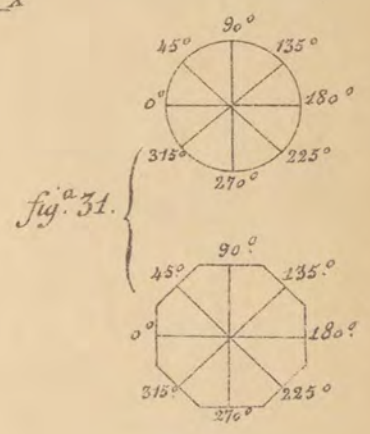
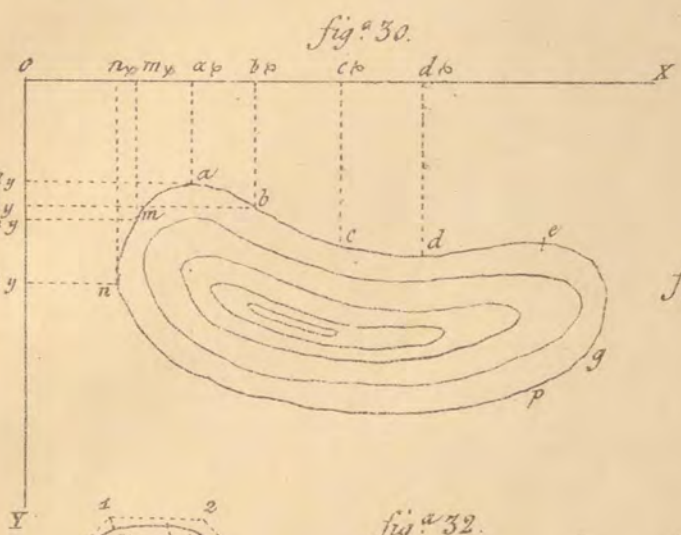
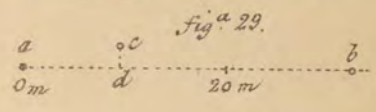
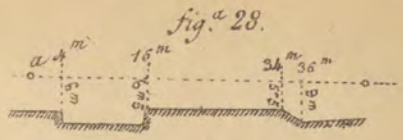
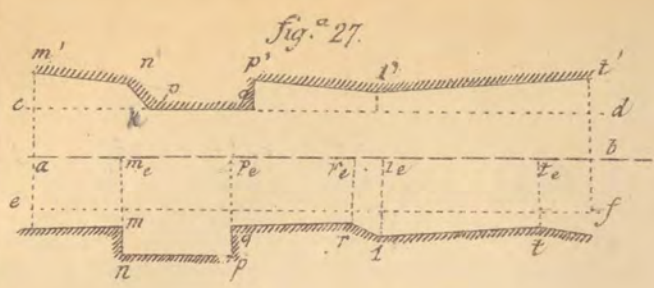
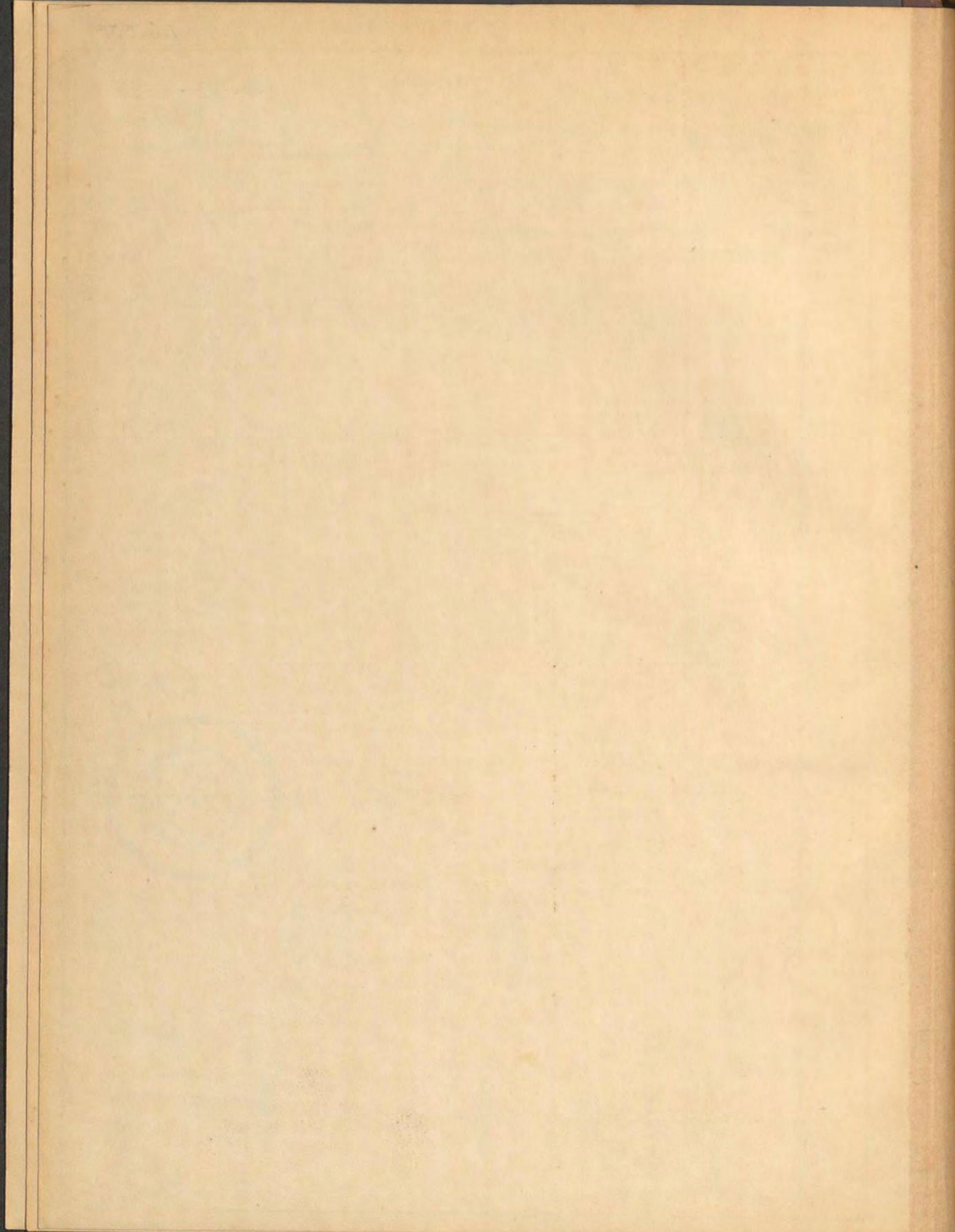


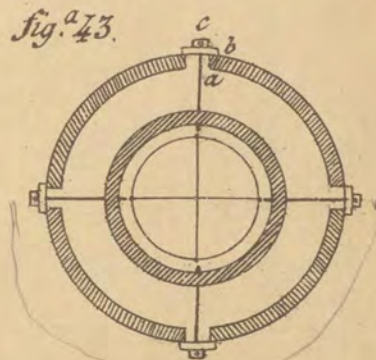
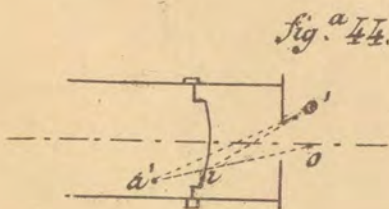
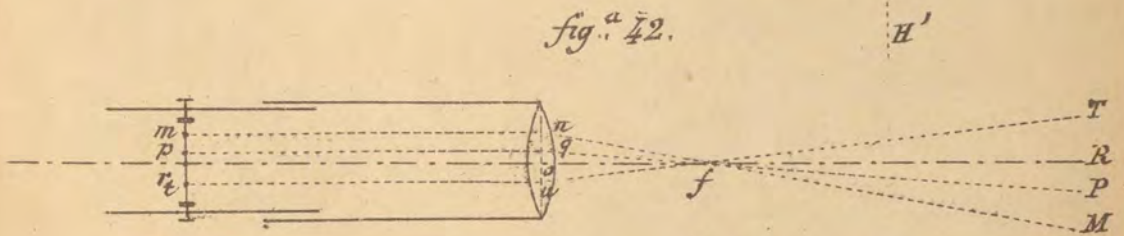
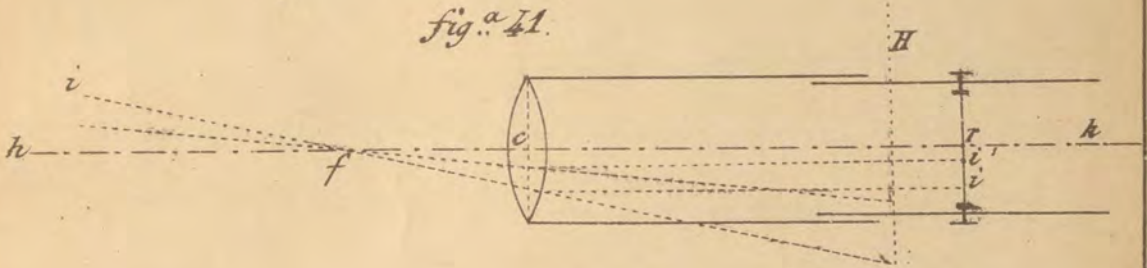
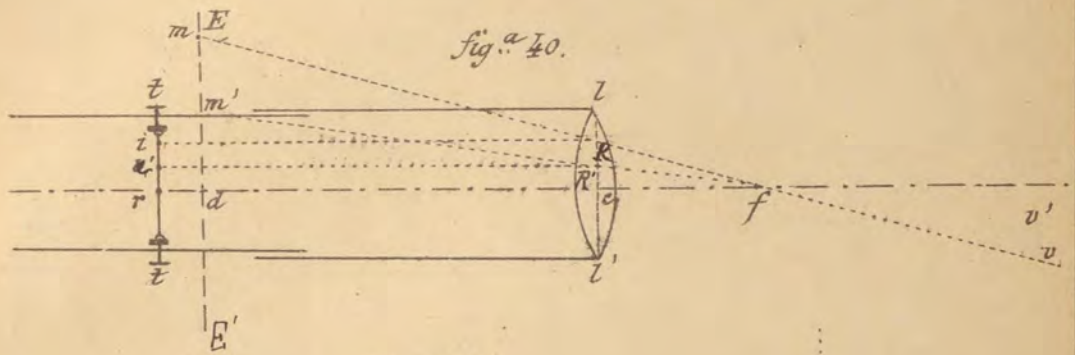
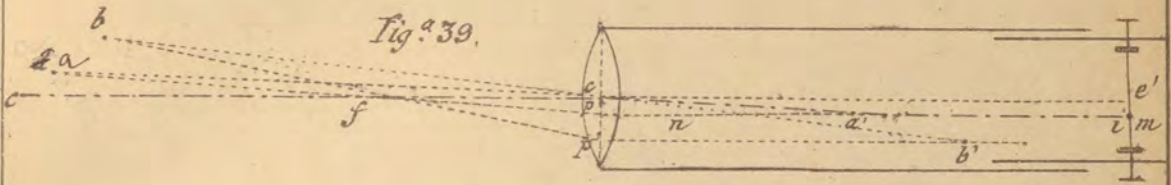
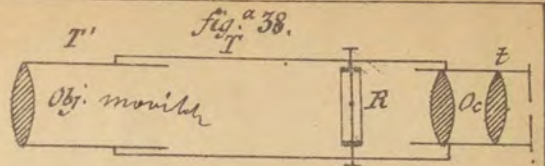
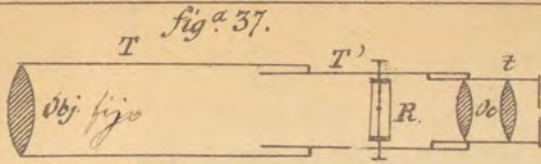
fig.<sup>a</sup> 26.

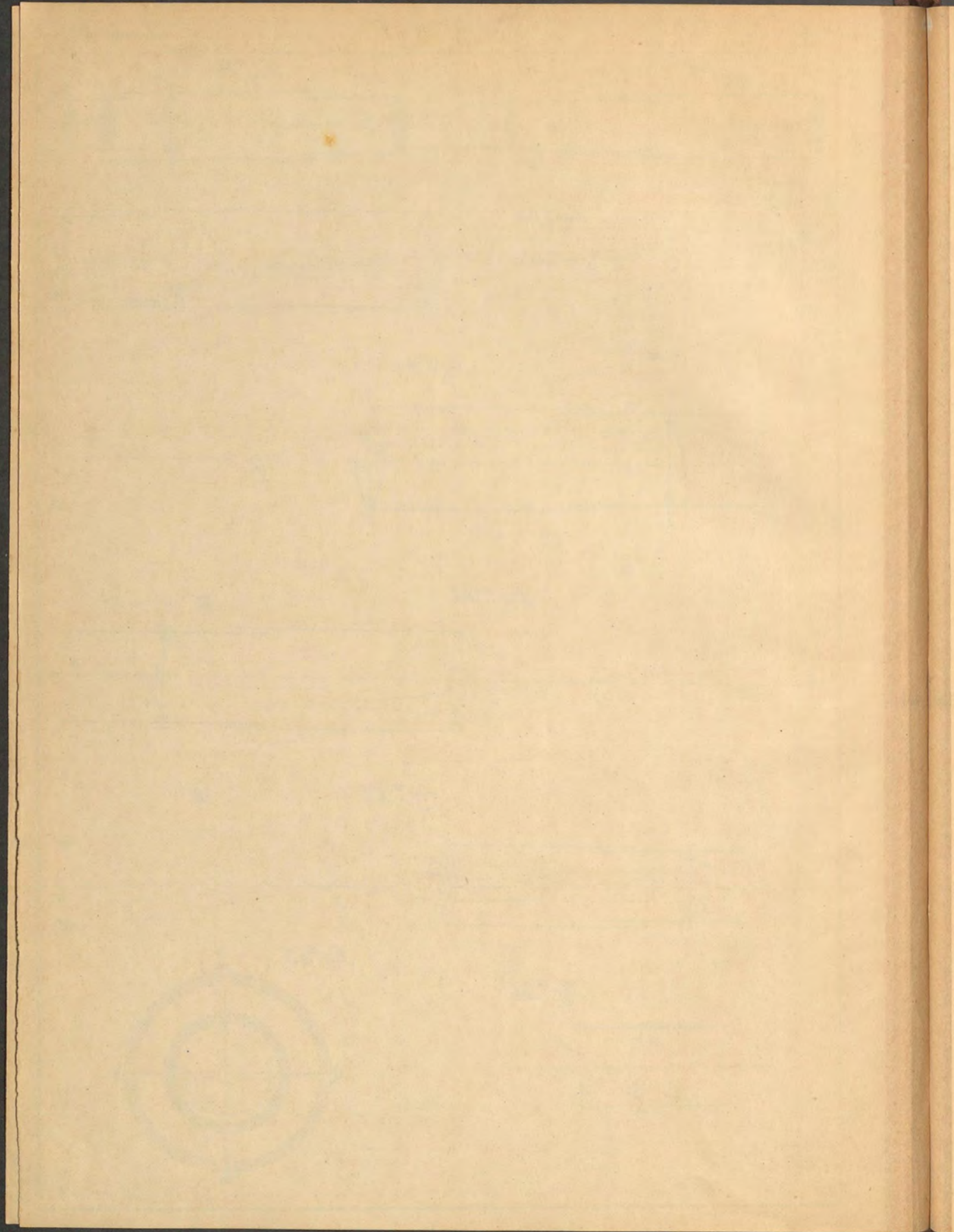


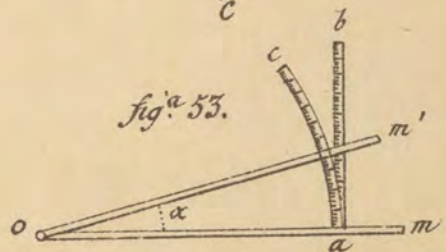
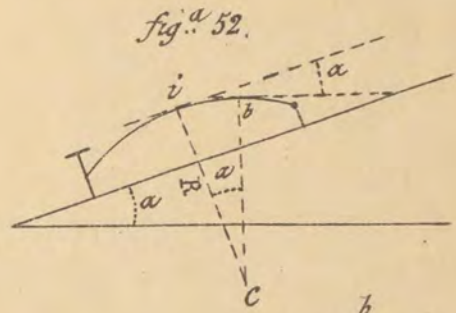
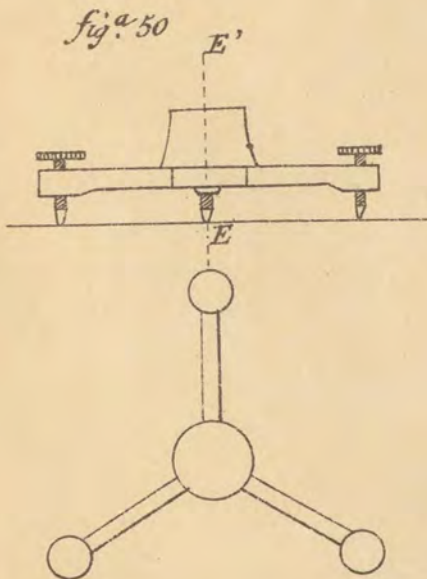
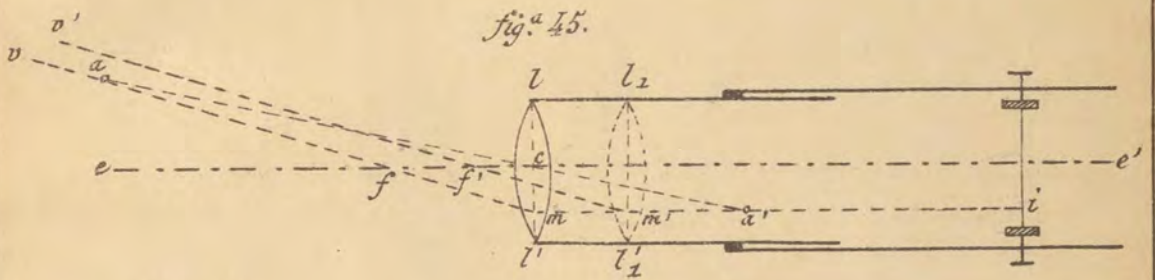
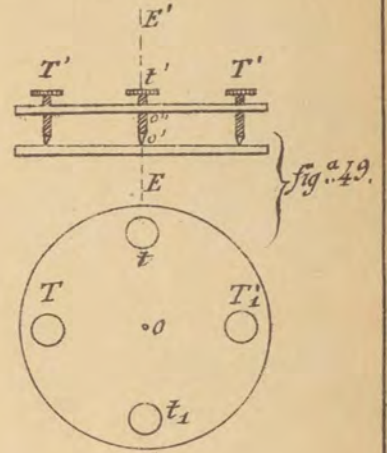
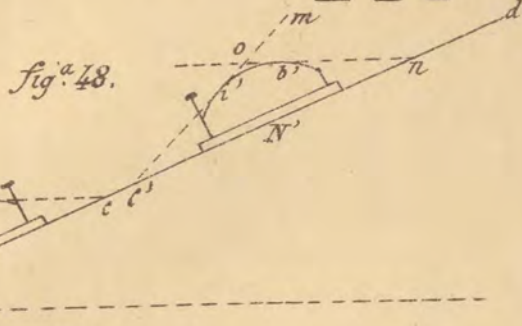
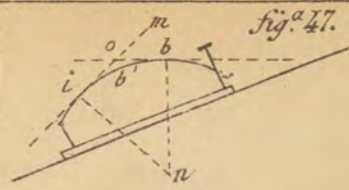
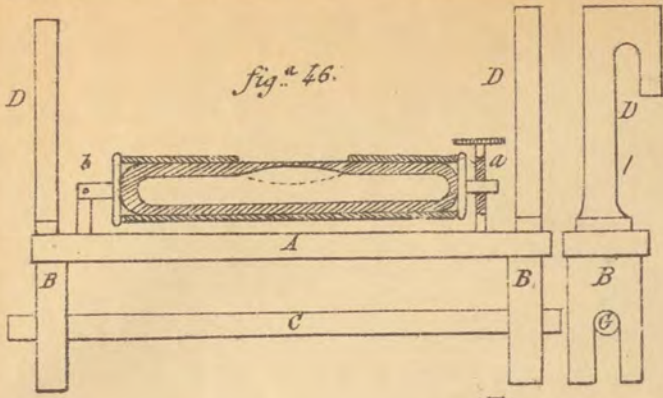












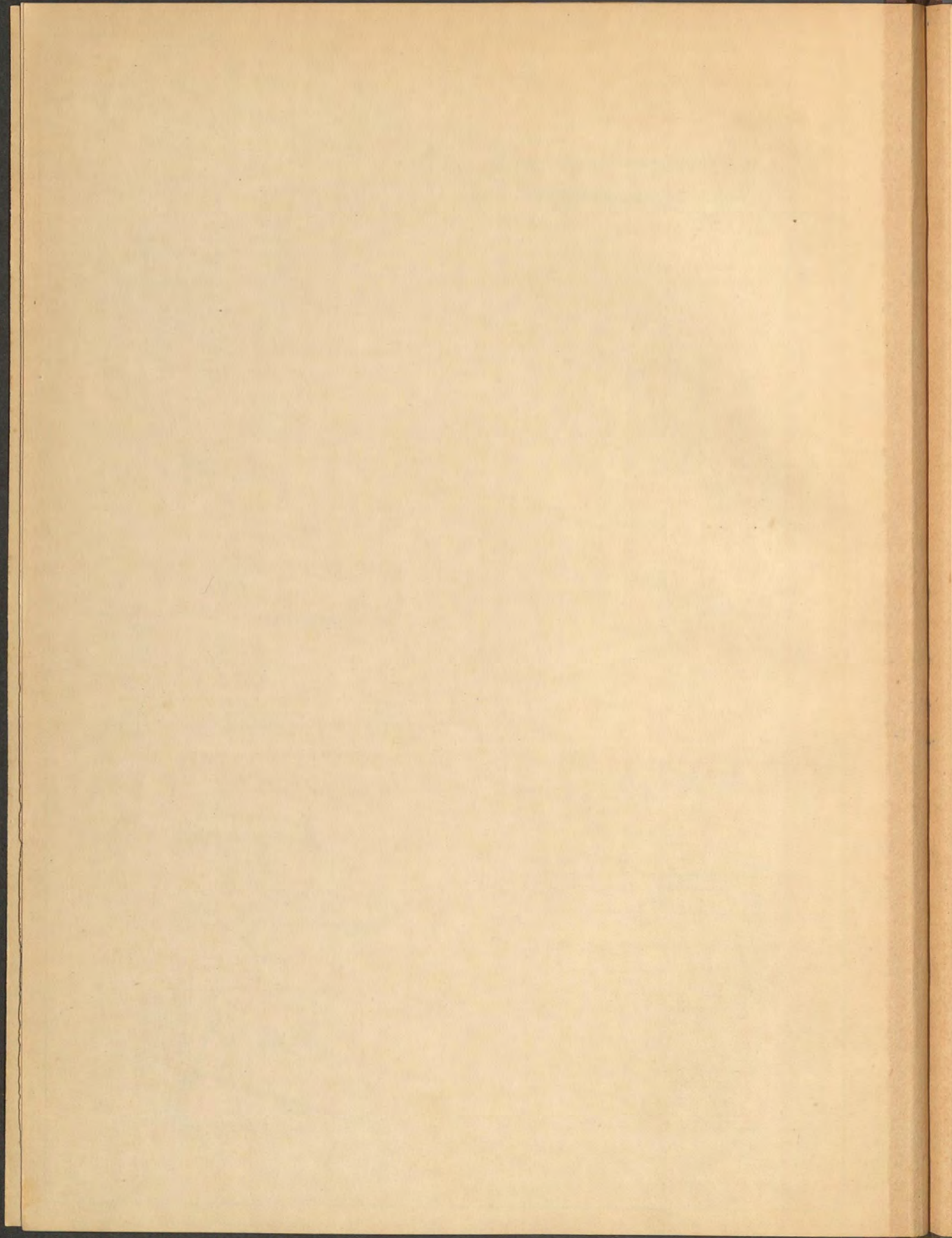


fig.<sup>a</sup> 60.

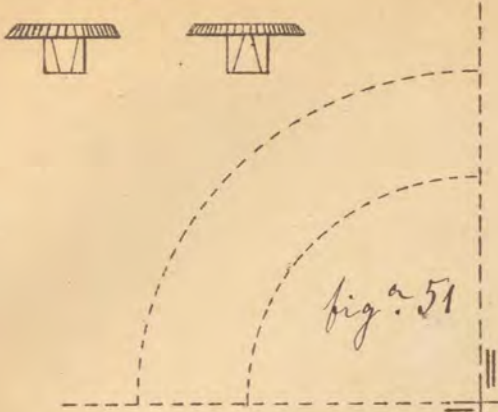


fig.<sup>a</sup> 51

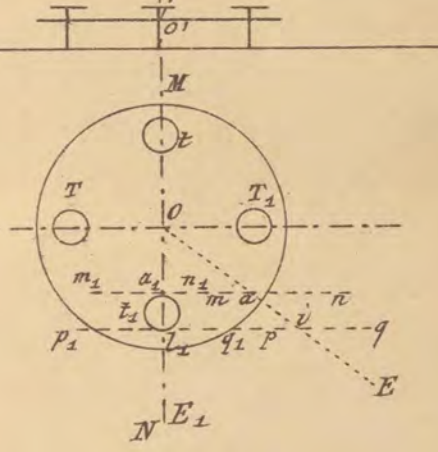
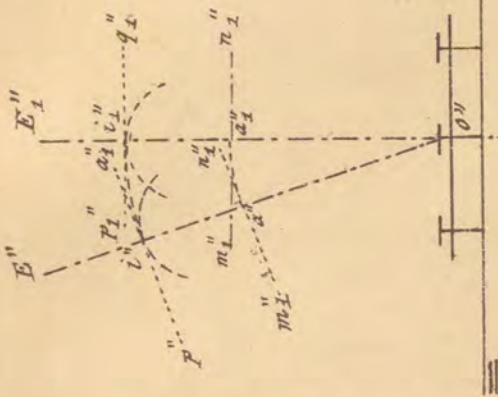
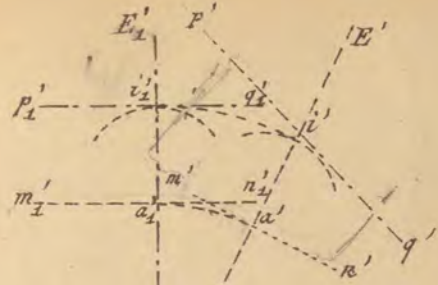


fig.<sup>a</sup> 54.

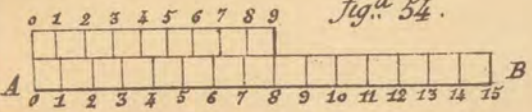


fig.<sup>a</sup> 55.

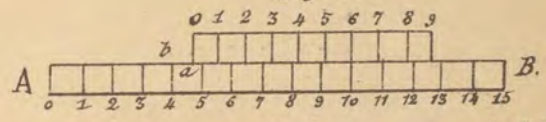


fig.<sup>a</sup> 56.



fig.<sup>a</sup> 57.

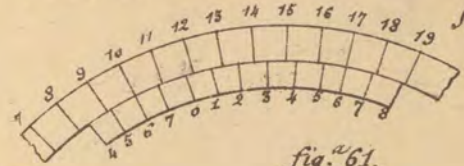


fig.<sup>a</sup> 59.

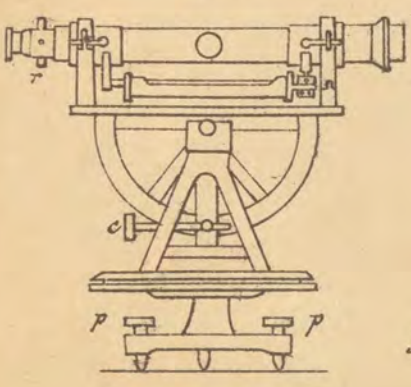


fig.<sup>a</sup> 58.

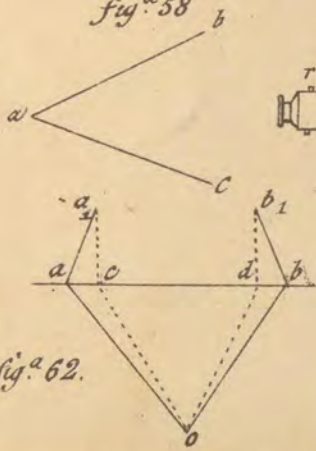


fig.<sup>a</sup> 61.

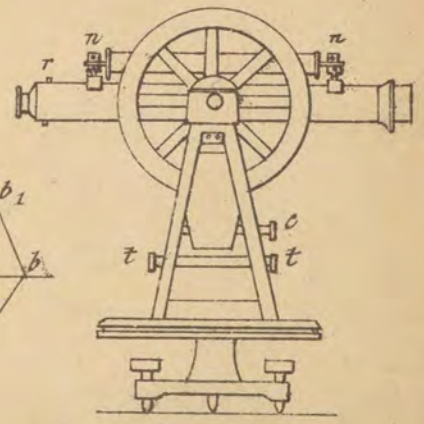
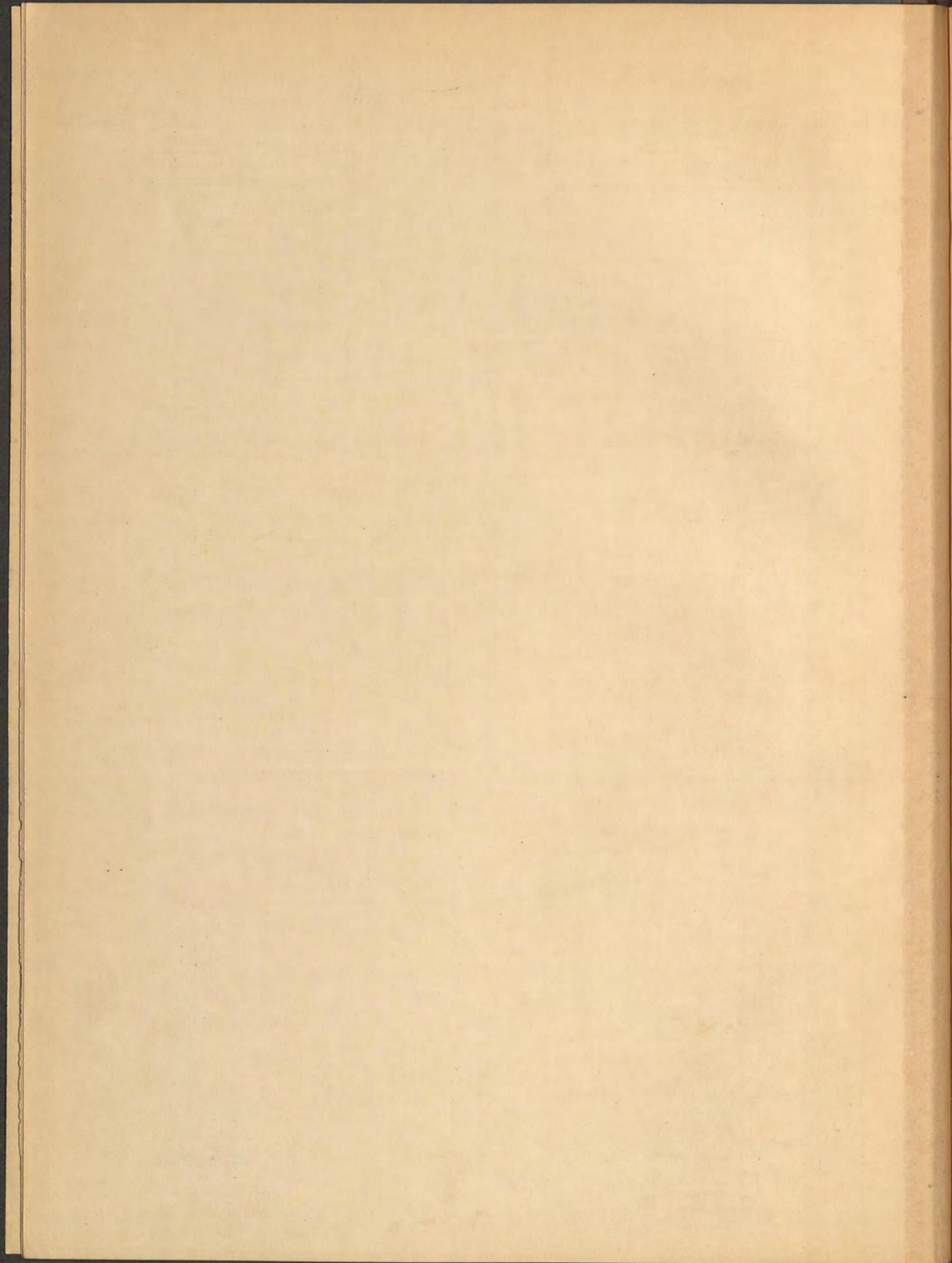


fig.<sup>a</sup> 62.



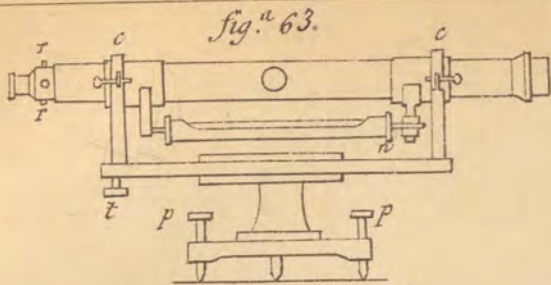


fig.<sup>a</sup> 63.

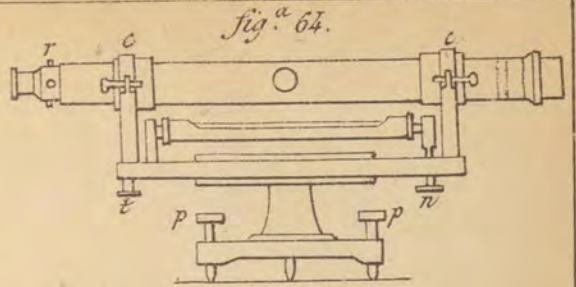


fig.<sup>a</sup> 64.

fig.<sup>a</sup> 65.

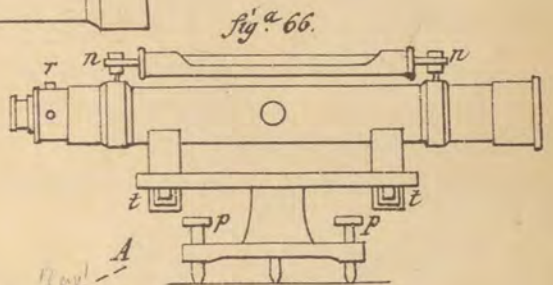
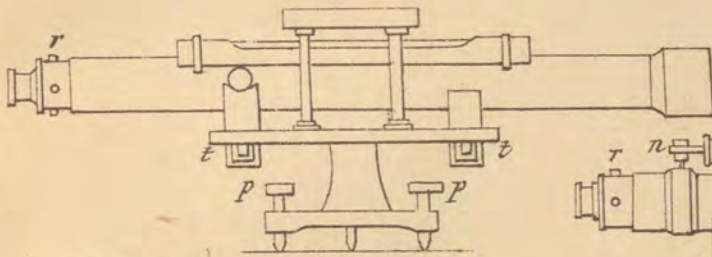


fig.<sup>a</sup> 66.

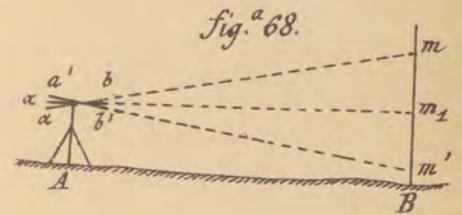
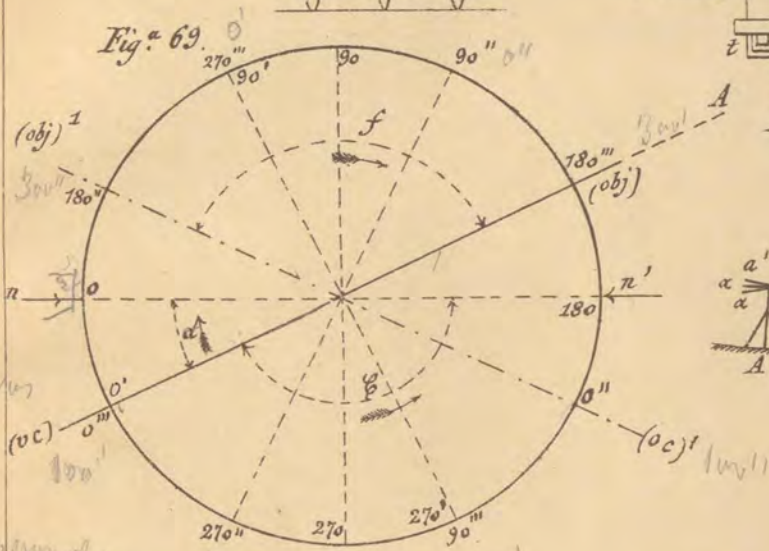


fig.<sup>a</sup> 68.

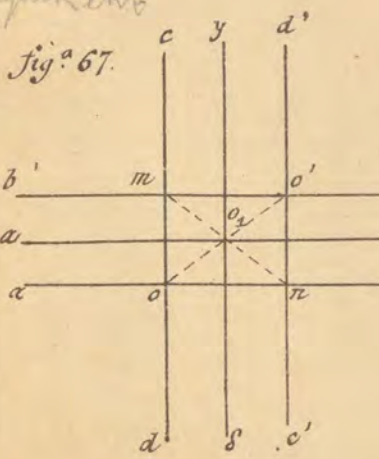


fig.<sup>a</sup> 67.

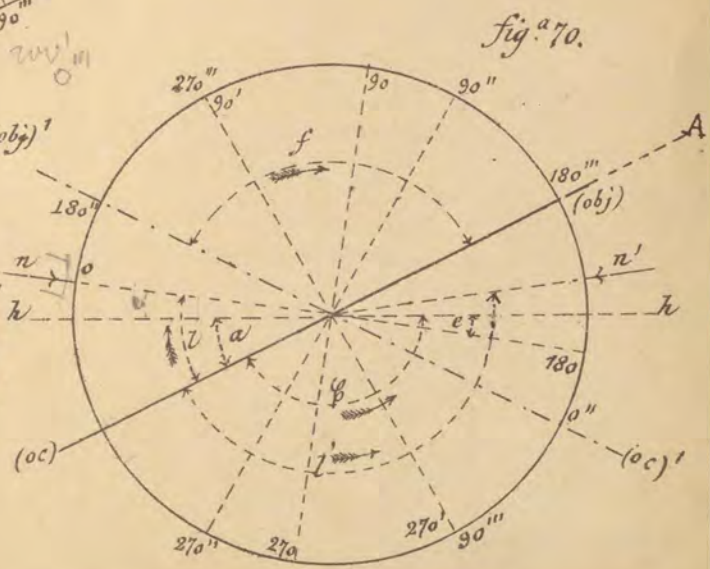


fig.<sup>a</sup> 70.

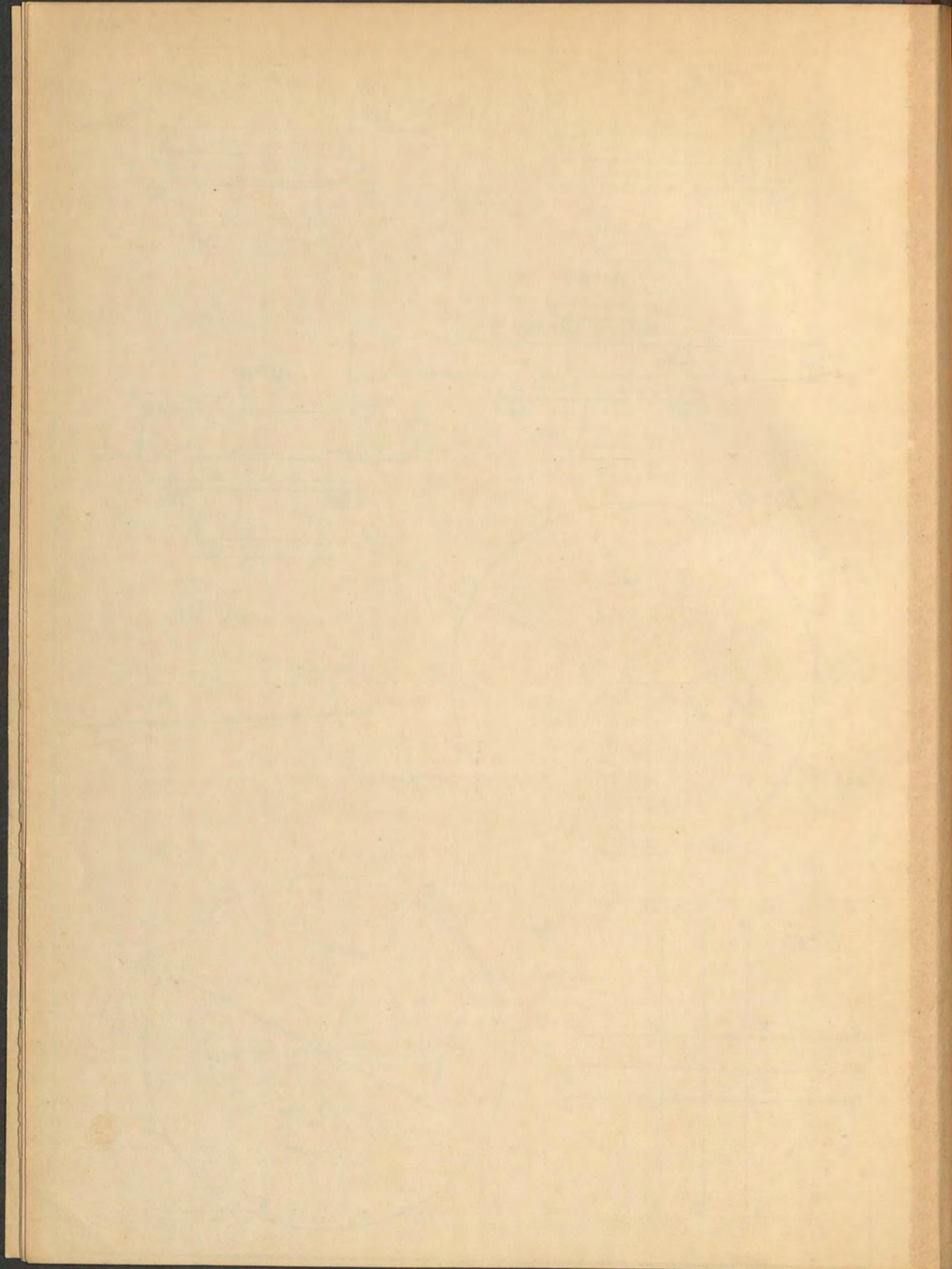


fig.<sup>a</sup> 71.

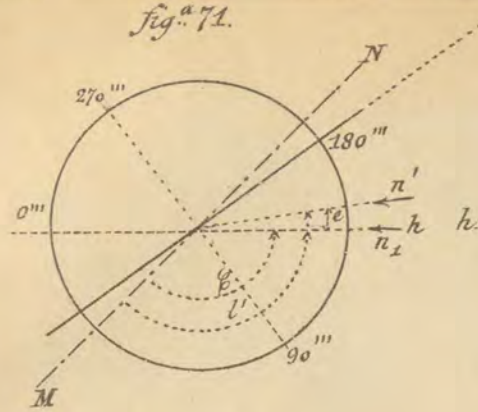


fig.<sup>a</sup> 72.

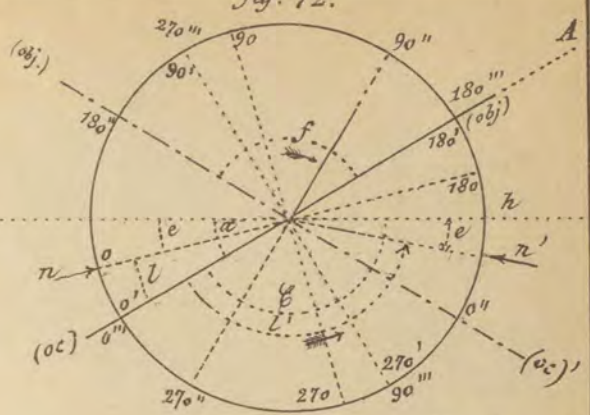


fig.<sup>a</sup> 74.

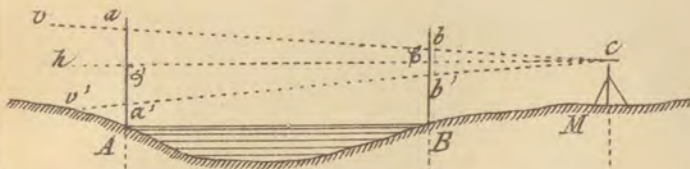


Fig. 73.

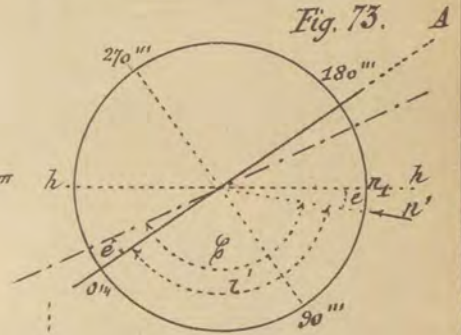


fig.<sup>a</sup> 75.

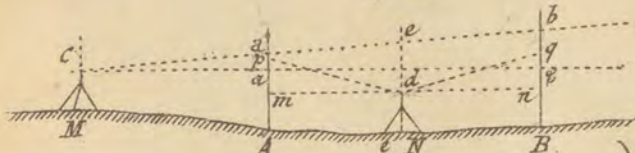


fig.<sup>a</sup> 76.

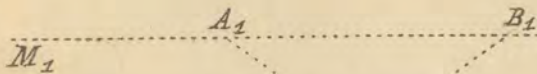
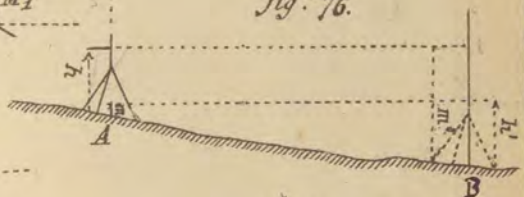
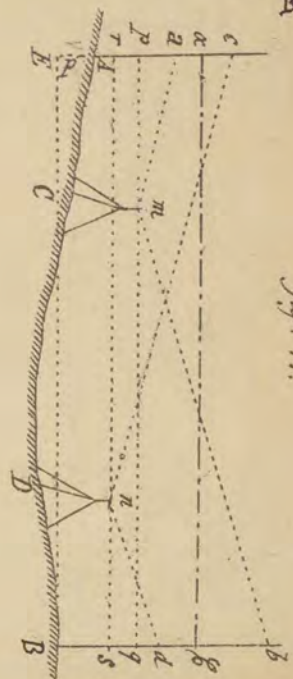
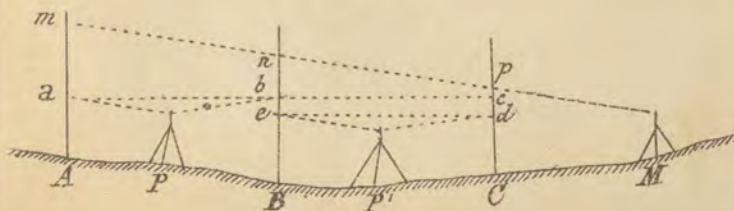


fig.<sup>a</sup> 77.

fig.<sup>a</sup> 78.



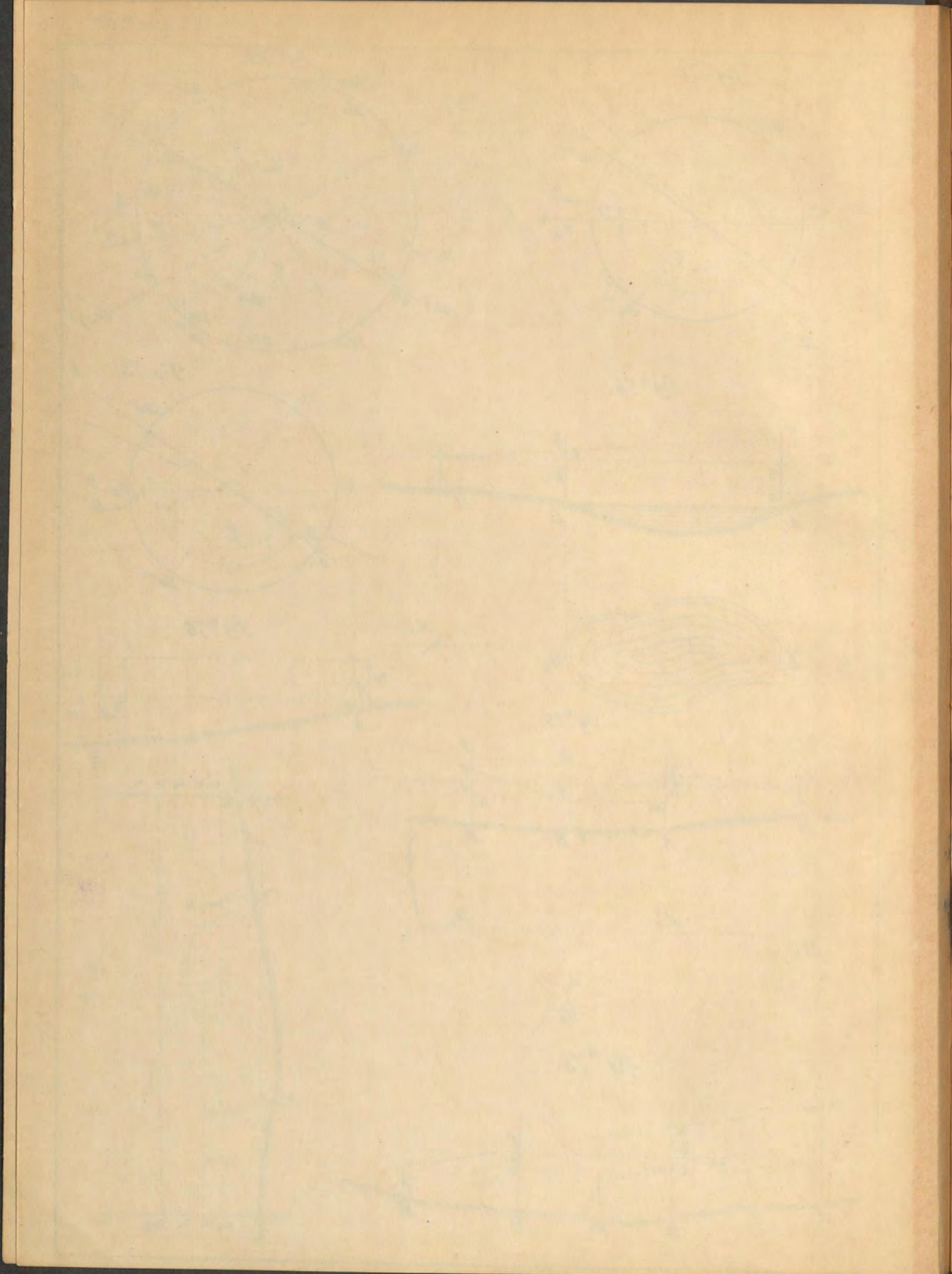


fig.<sup>a</sup> 79.

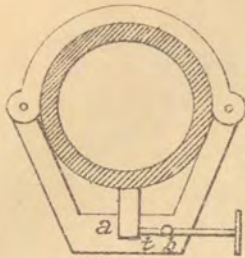


fig.<sup>a</sup> 81.

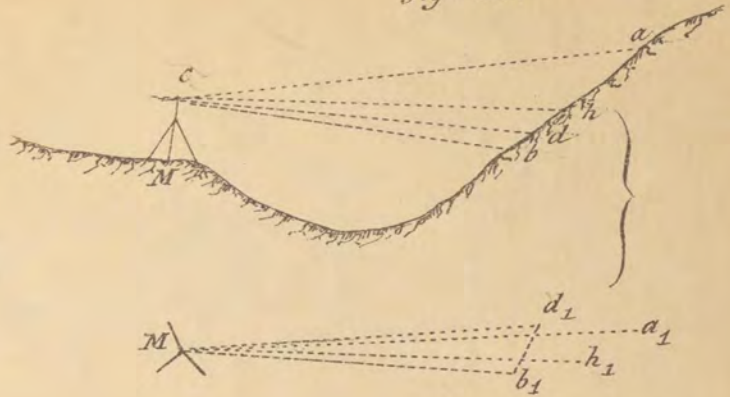


fig.<sup>a</sup> 80.

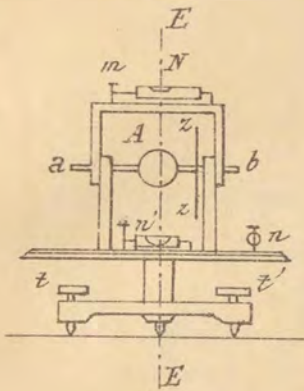


fig.<sup>a</sup> 83.

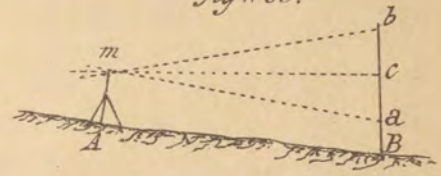


fig.<sup>a</sup> 82.

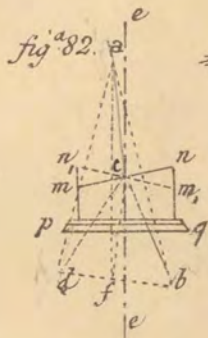


fig.<sup>a</sup> 84.

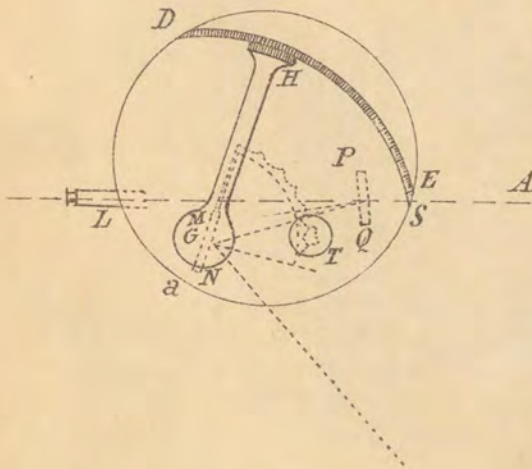
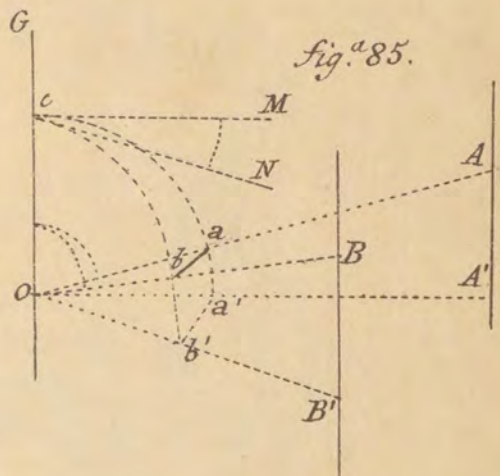
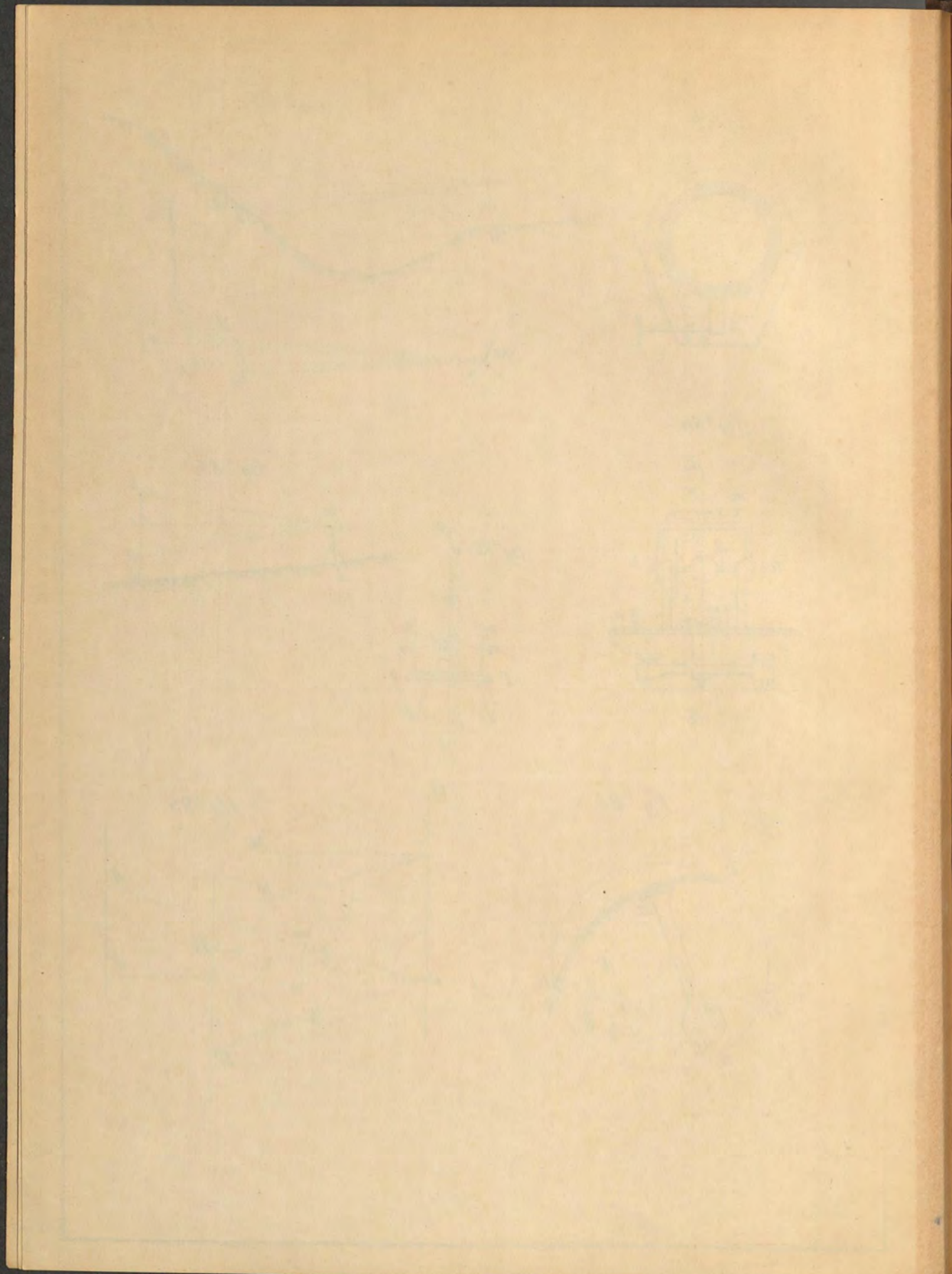
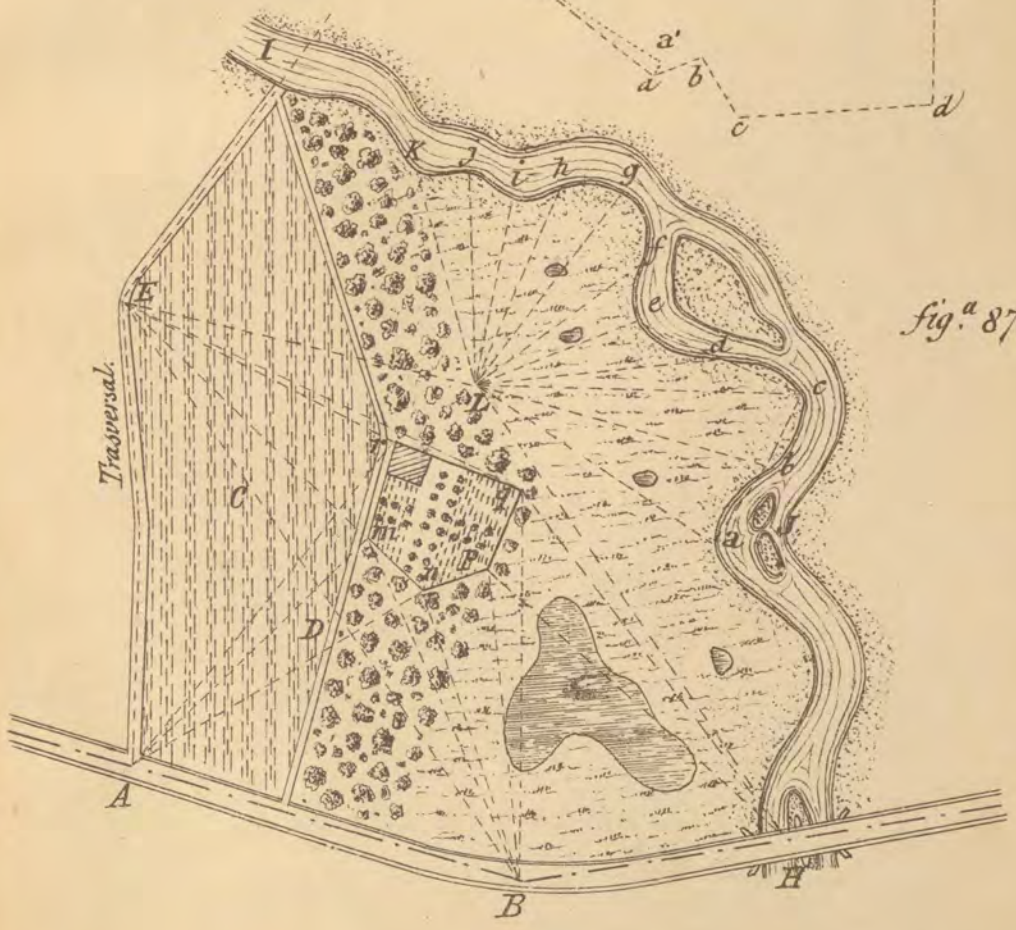
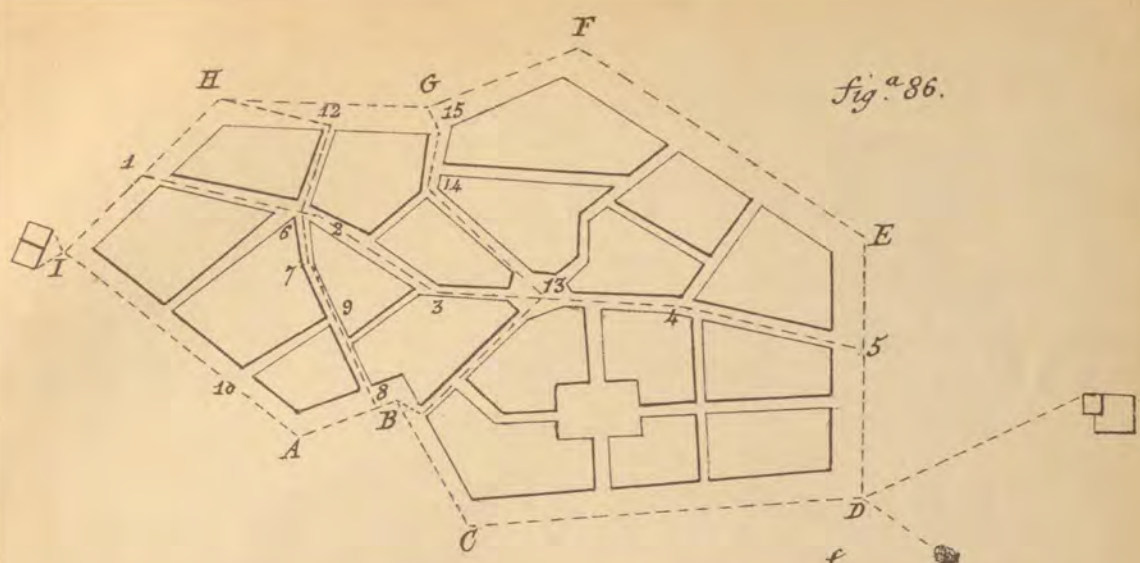


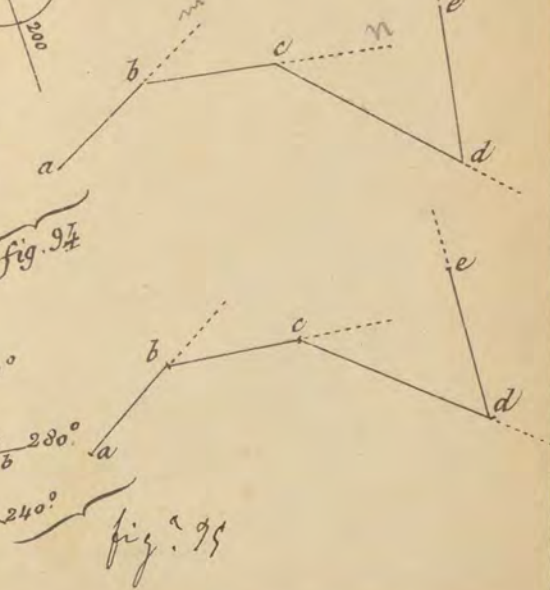
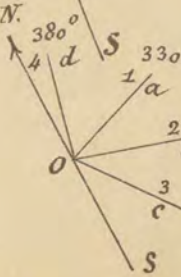
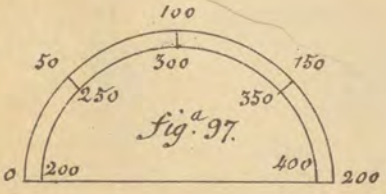
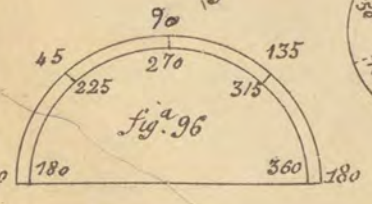
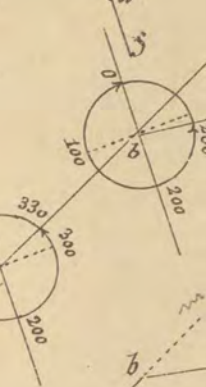
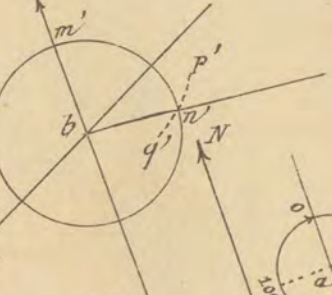
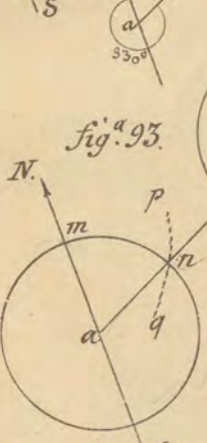
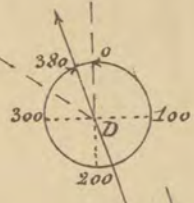
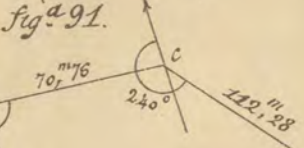
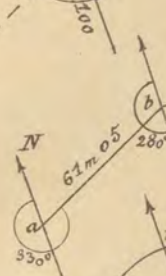
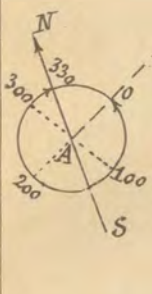
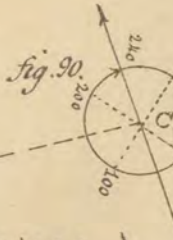
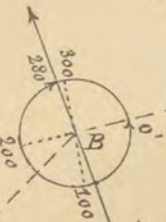
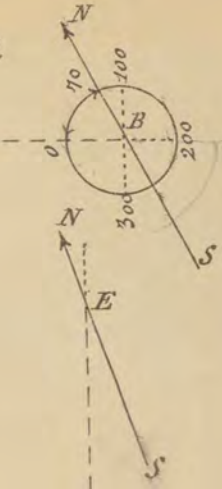
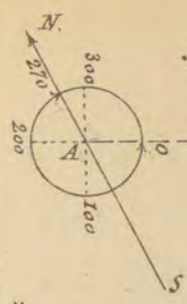
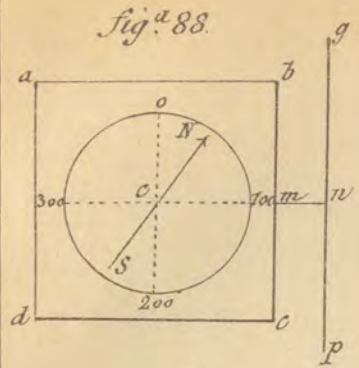
fig.<sup>a</sup> 85.

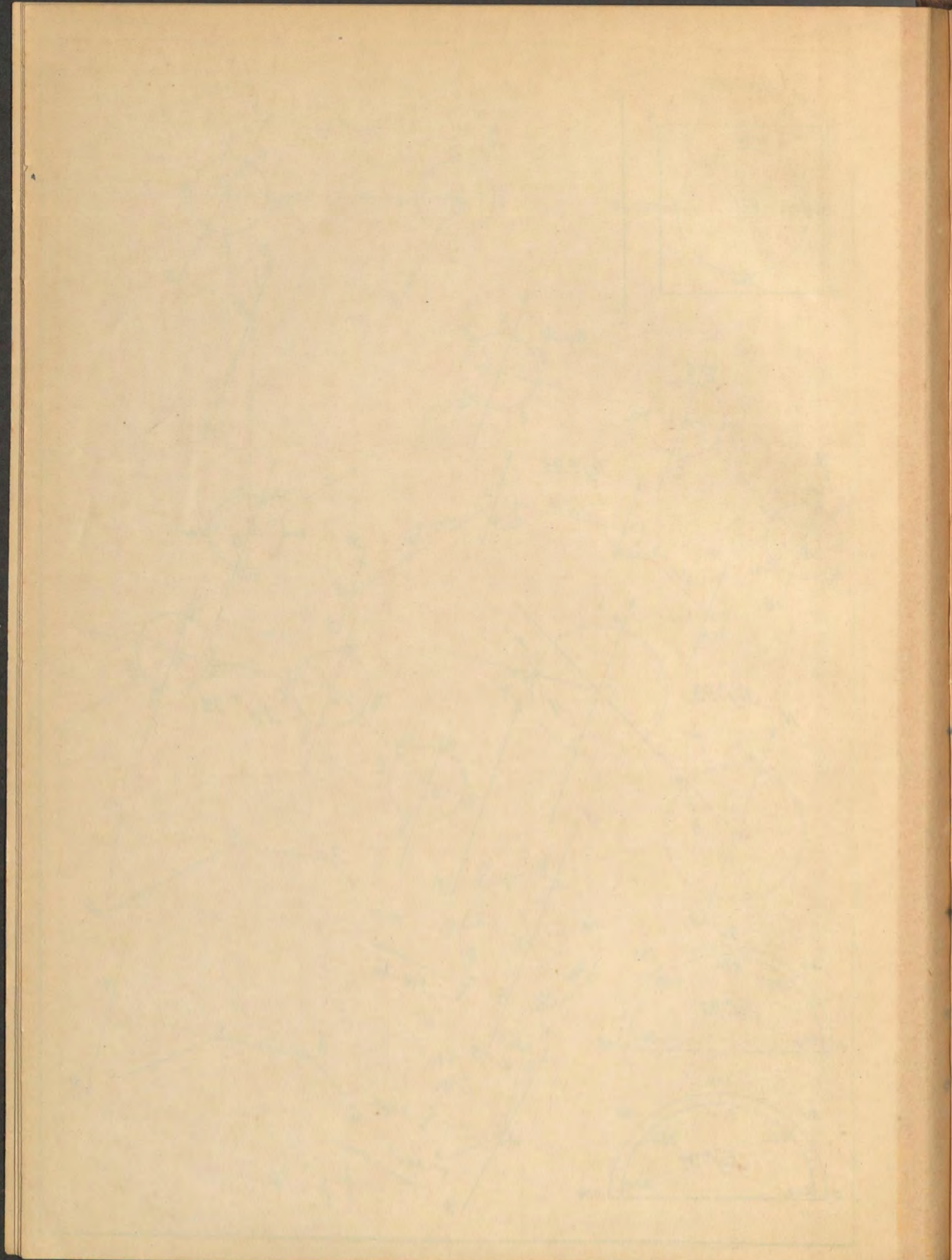


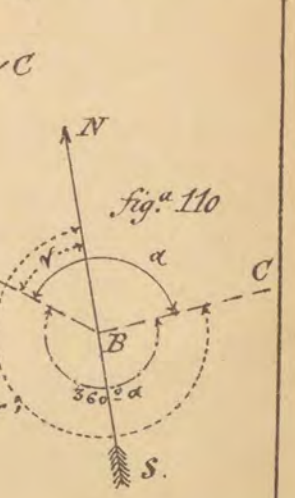
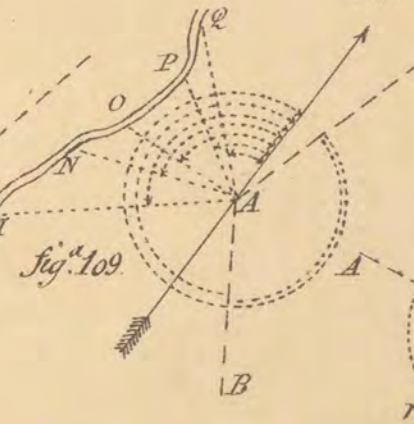
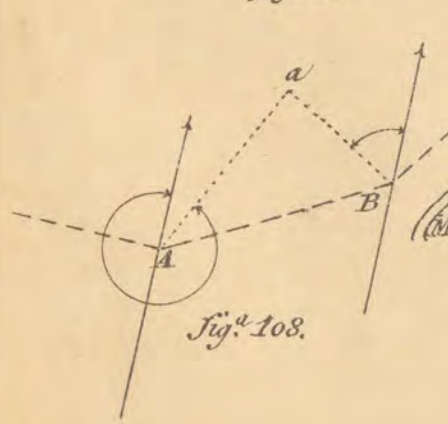
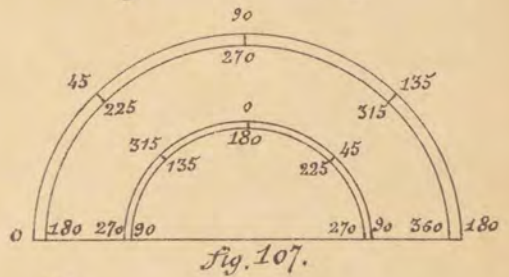
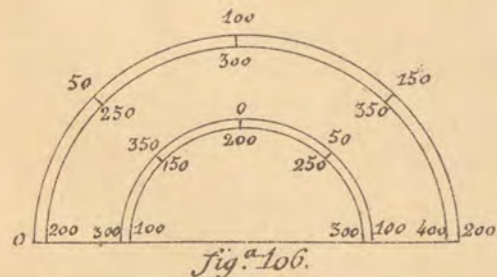
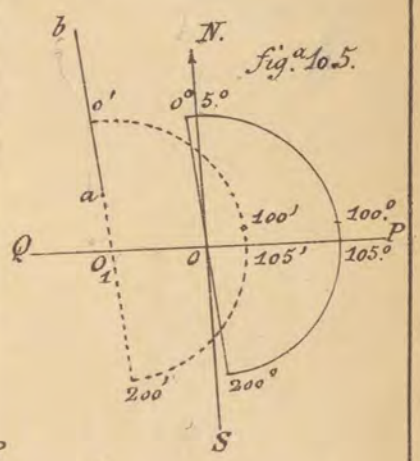
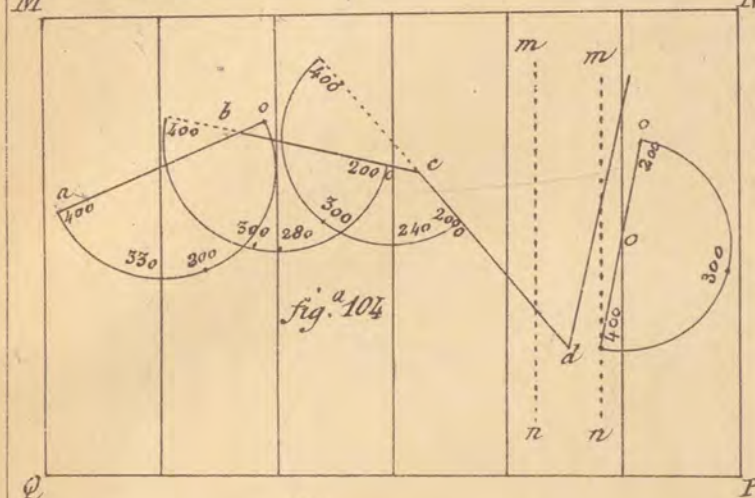
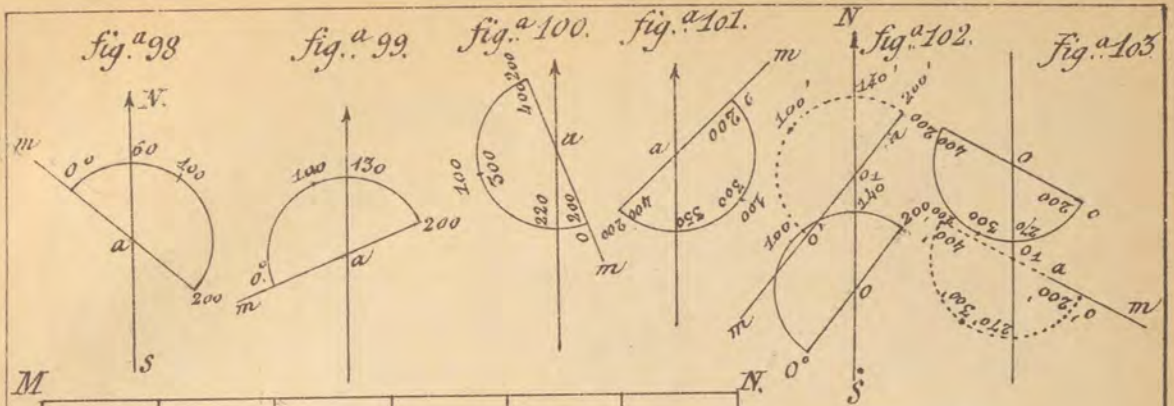












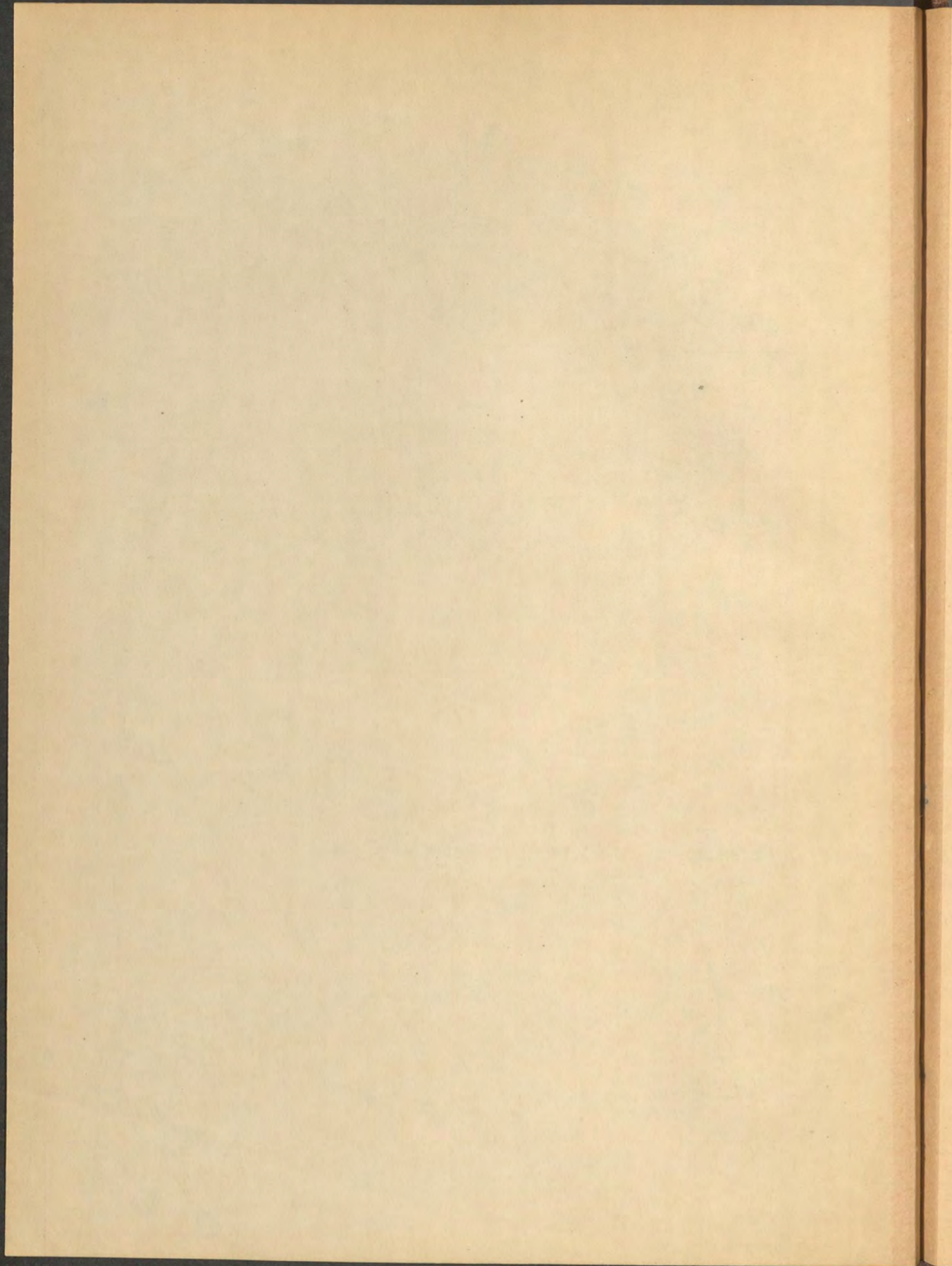


fig. 111.

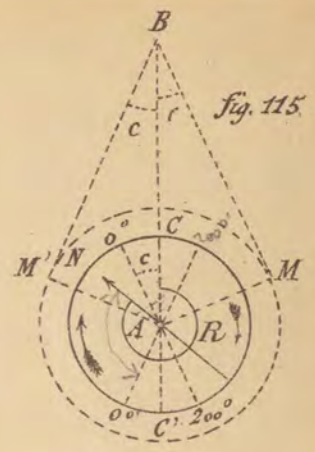
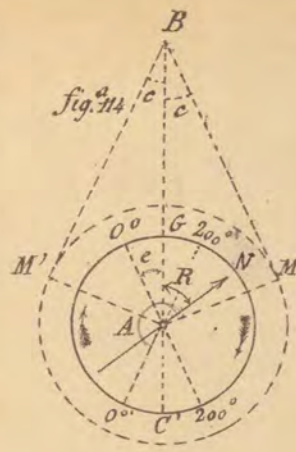
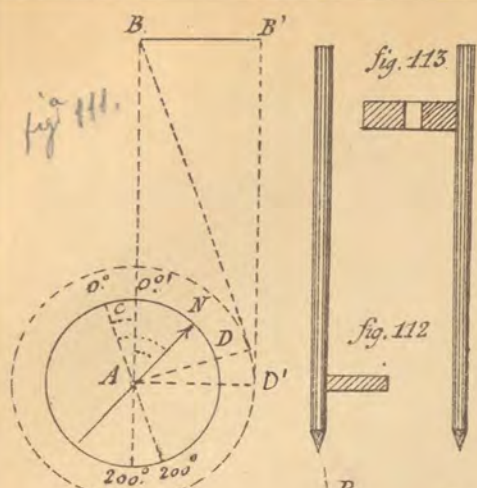


fig. 116

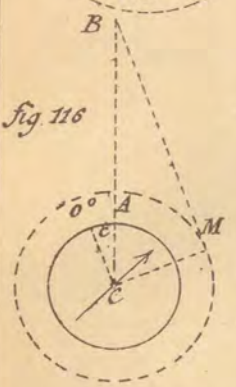


fig. 117

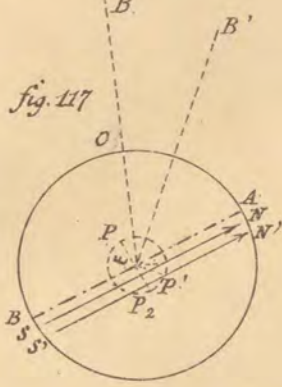


fig. 118

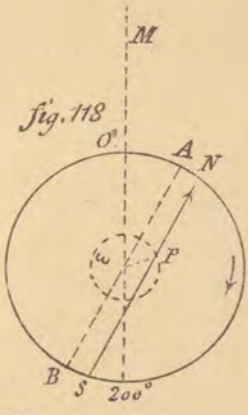


fig. 119

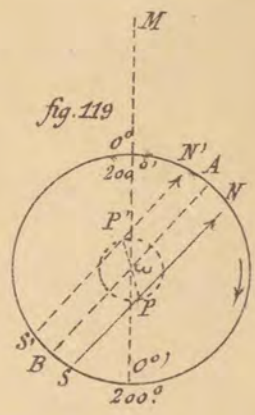


fig. 120.

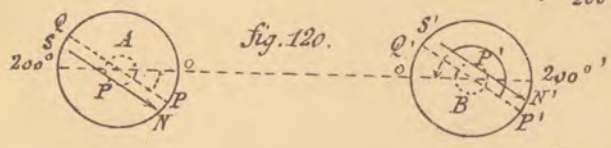


fig. 121.

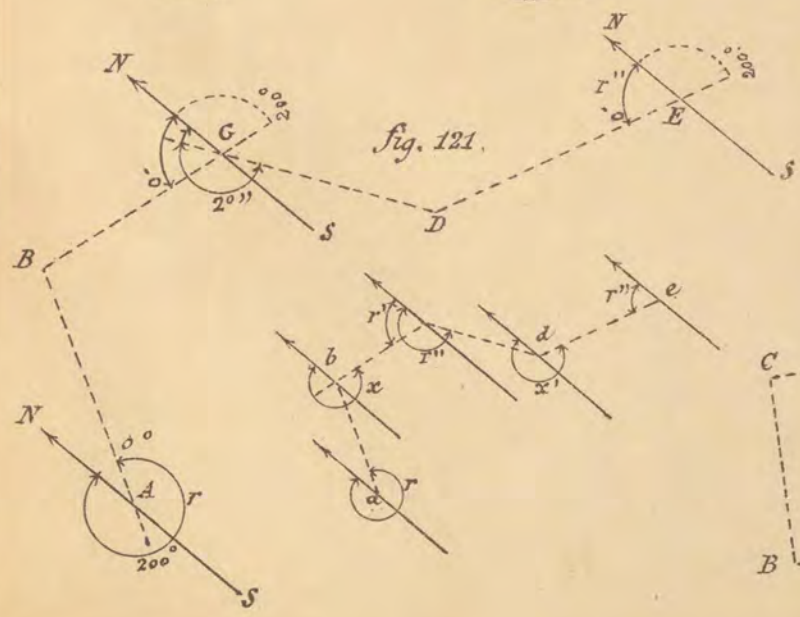
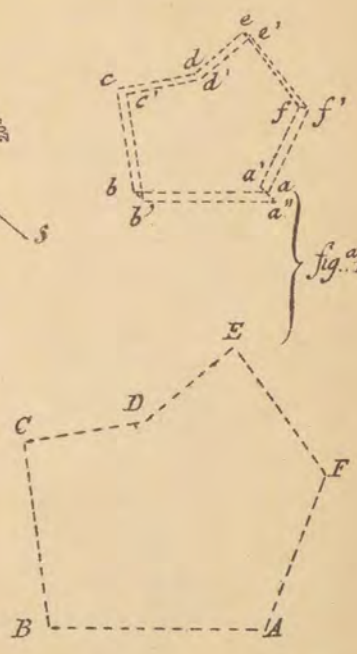


fig. 122.



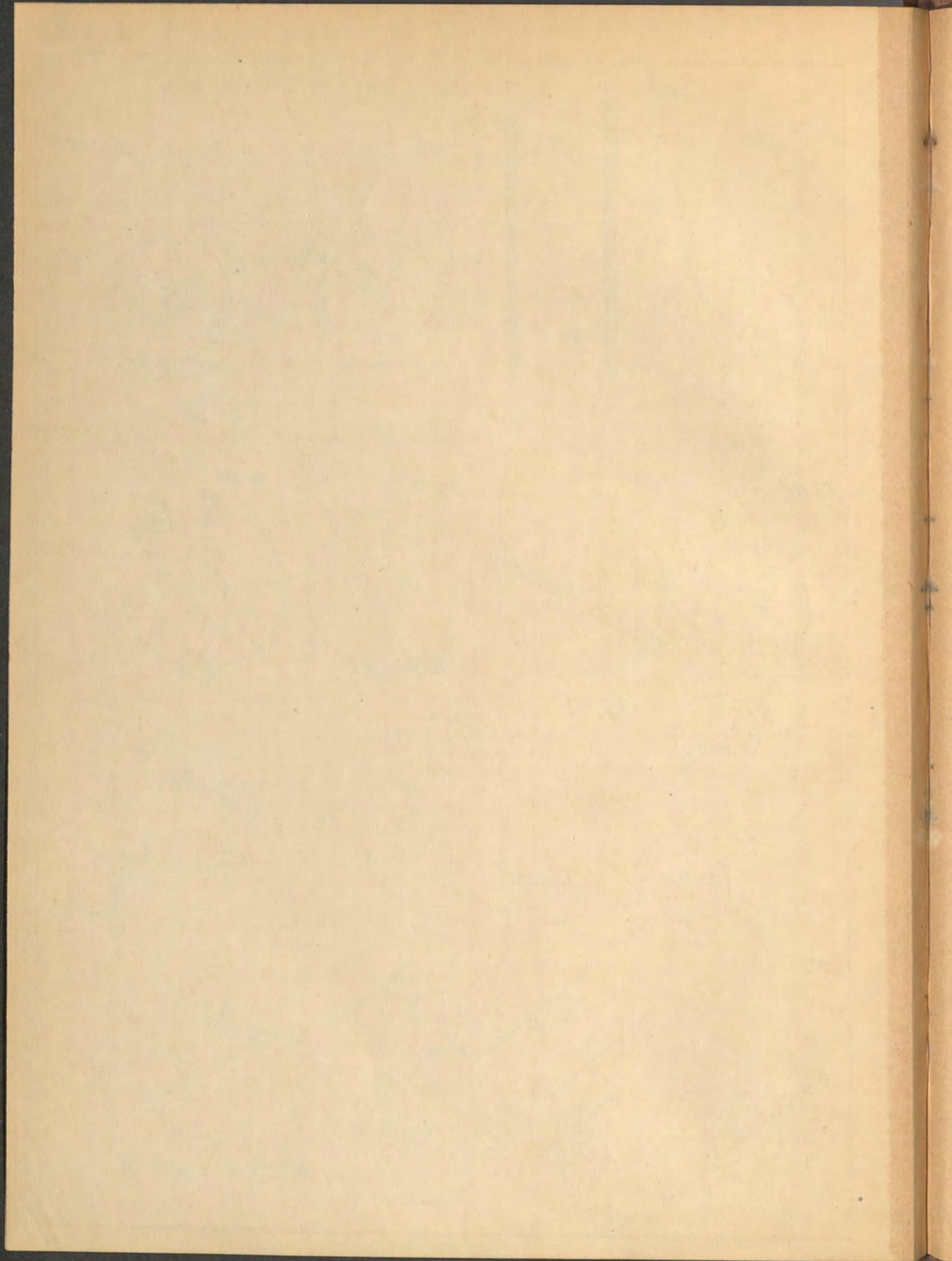


fig.<sup>a</sup> 123.

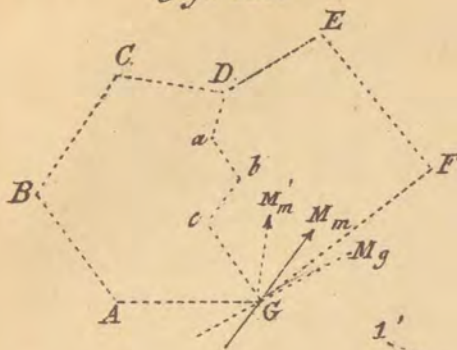


fig.<sup>a</sup> 125.



fig.<sup>a</sup> 124.

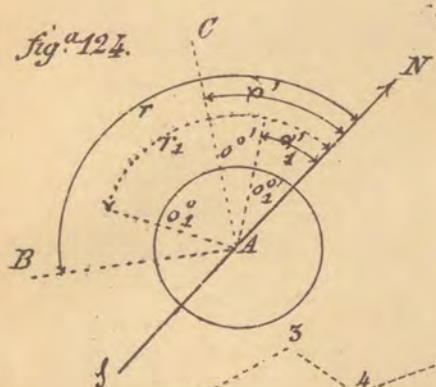


fig.<sup>a</sup> 128.



fig.<sup>a</sup> 129.

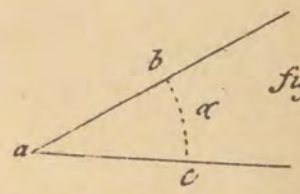


fig.<sup>a</sup> 130.

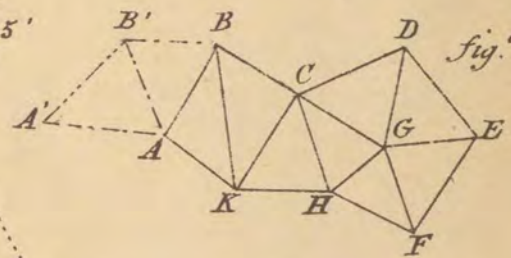


fig.<sup>a</sup> 126.

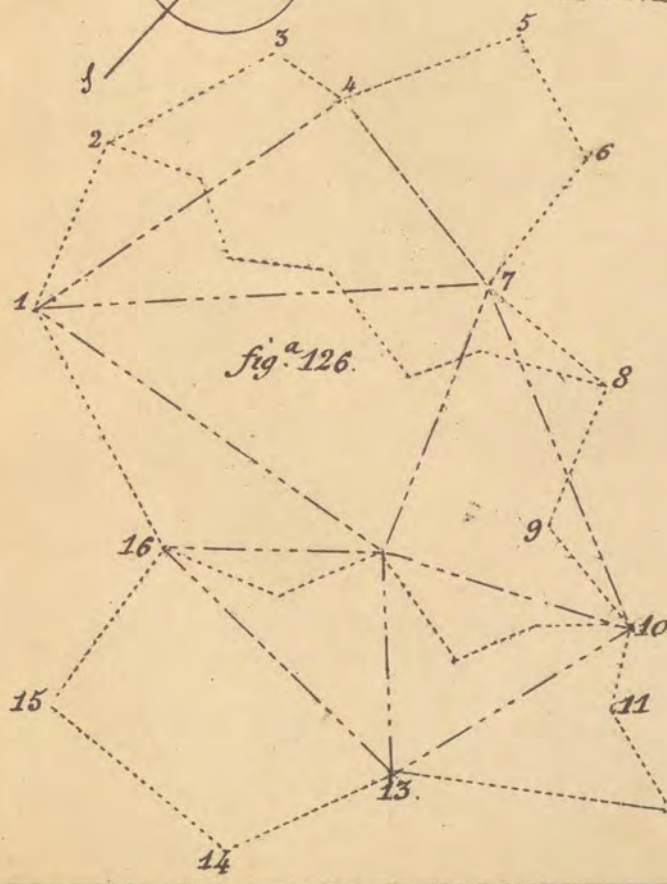
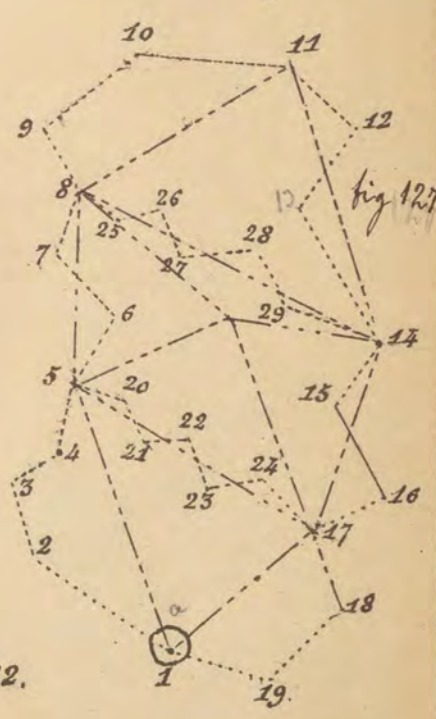
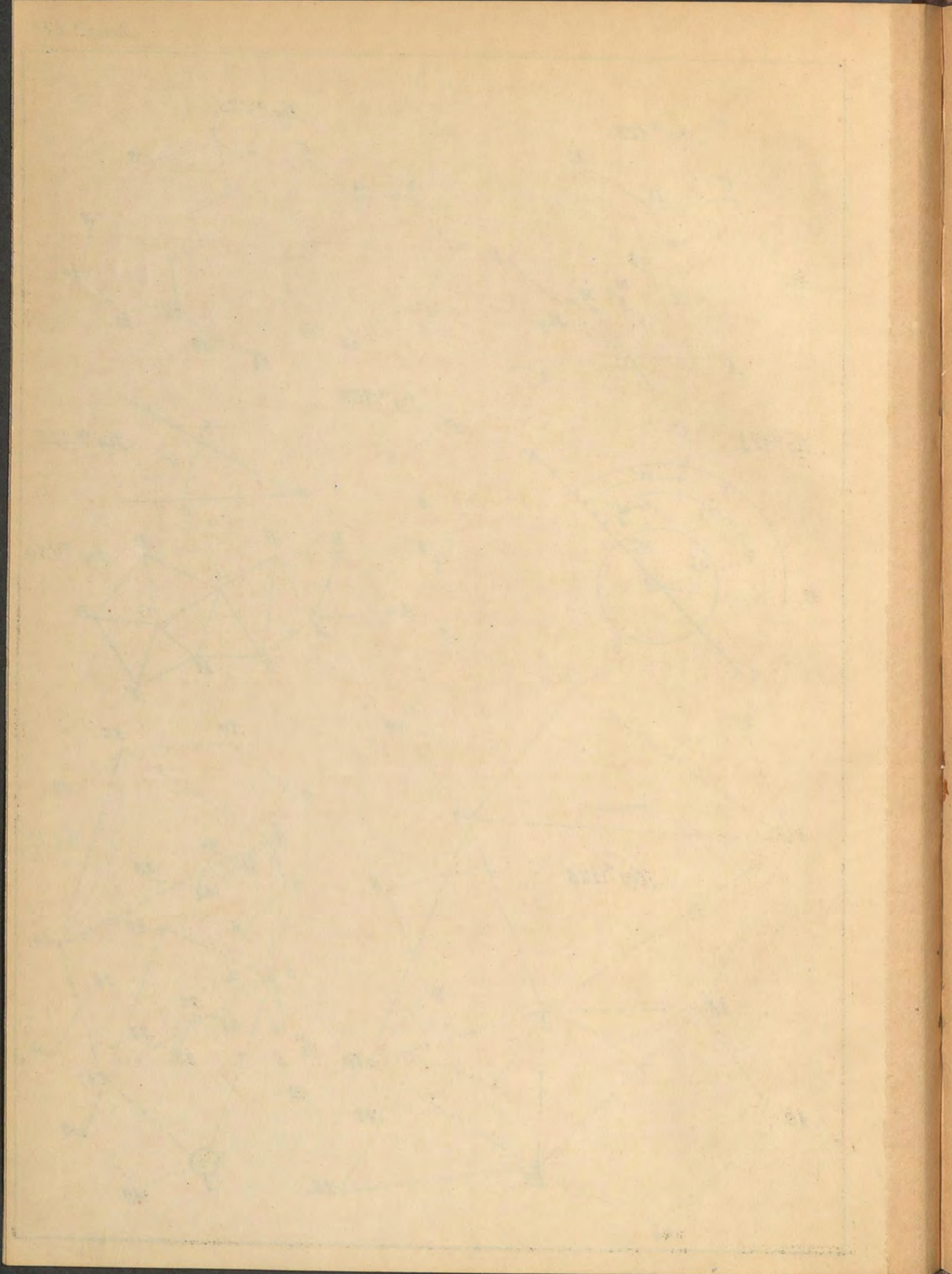
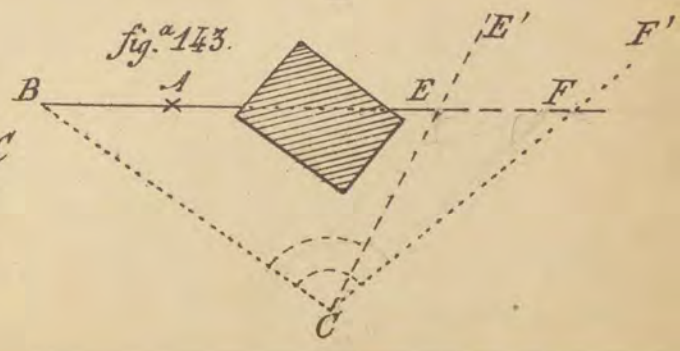
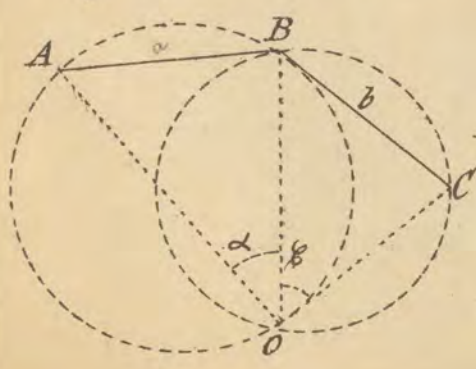
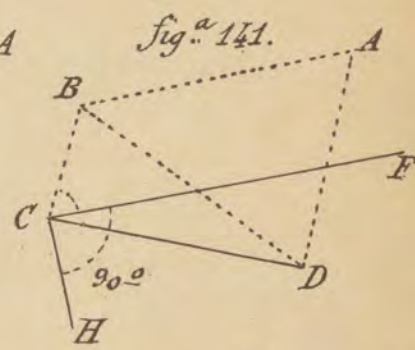
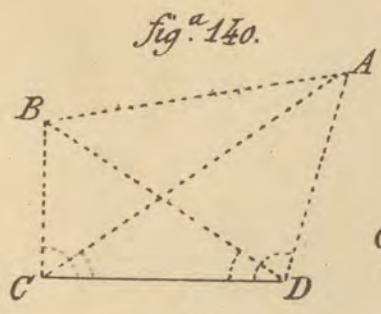
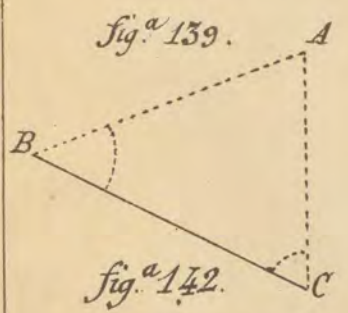
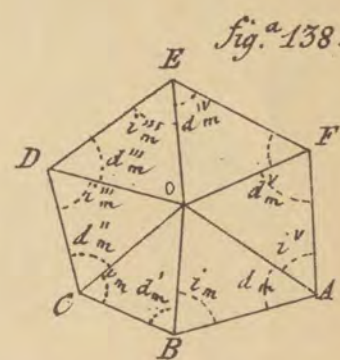
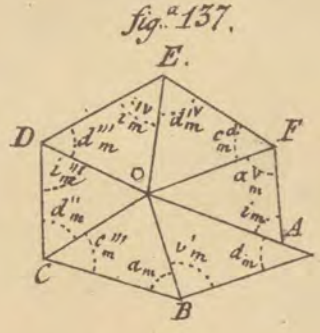
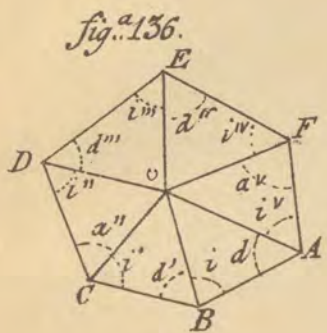
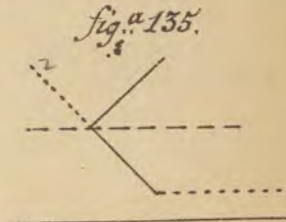
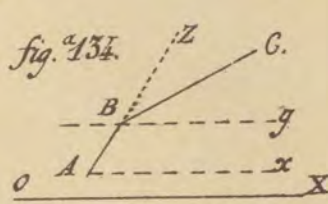
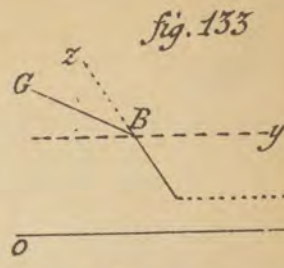
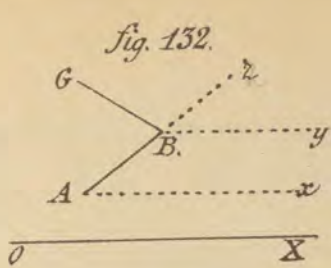
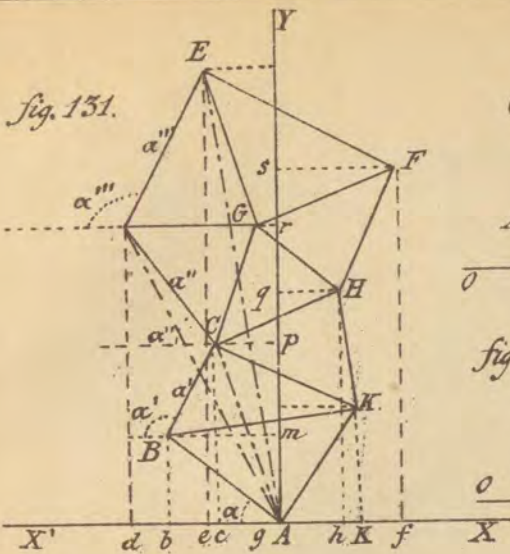
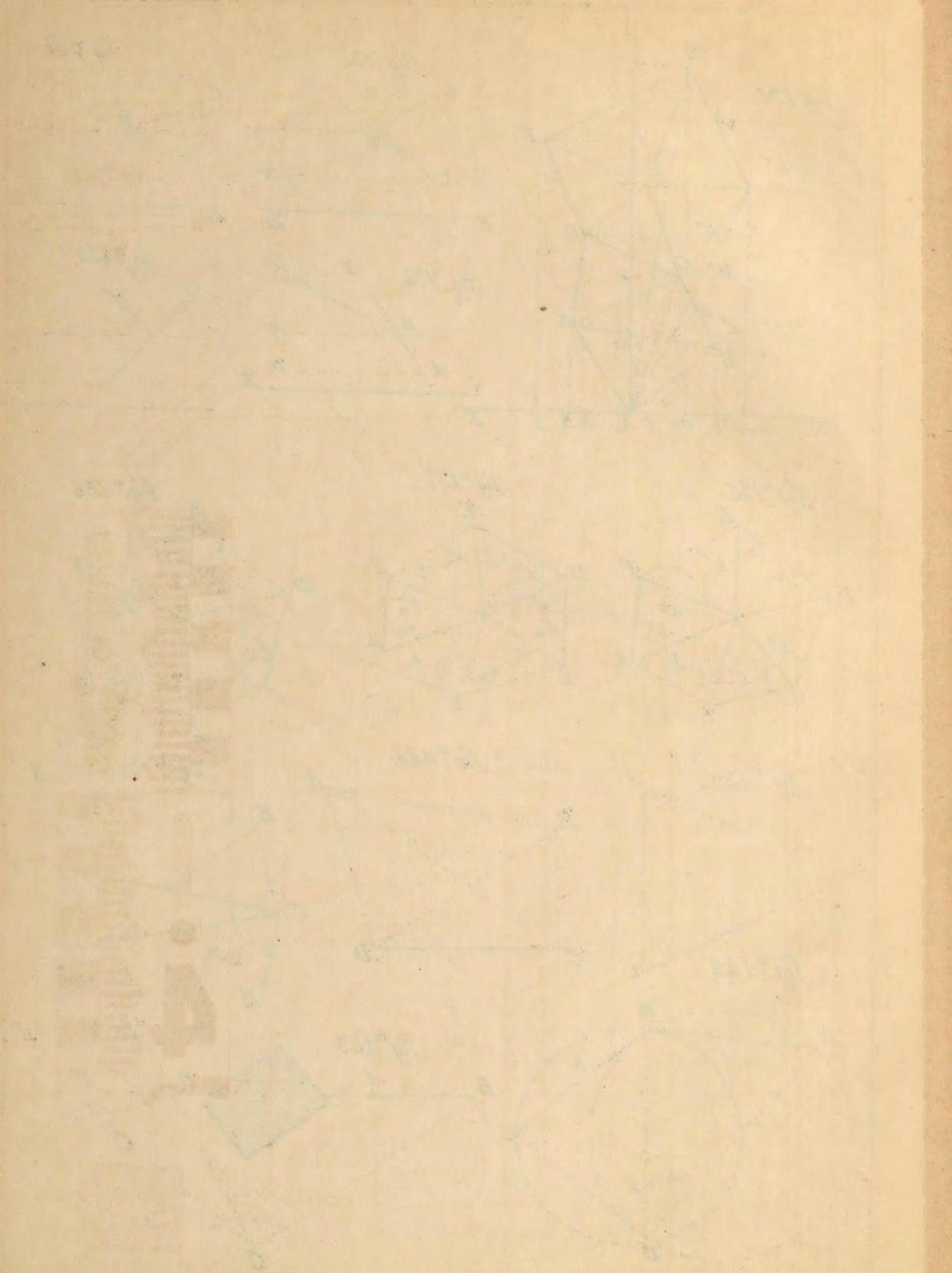


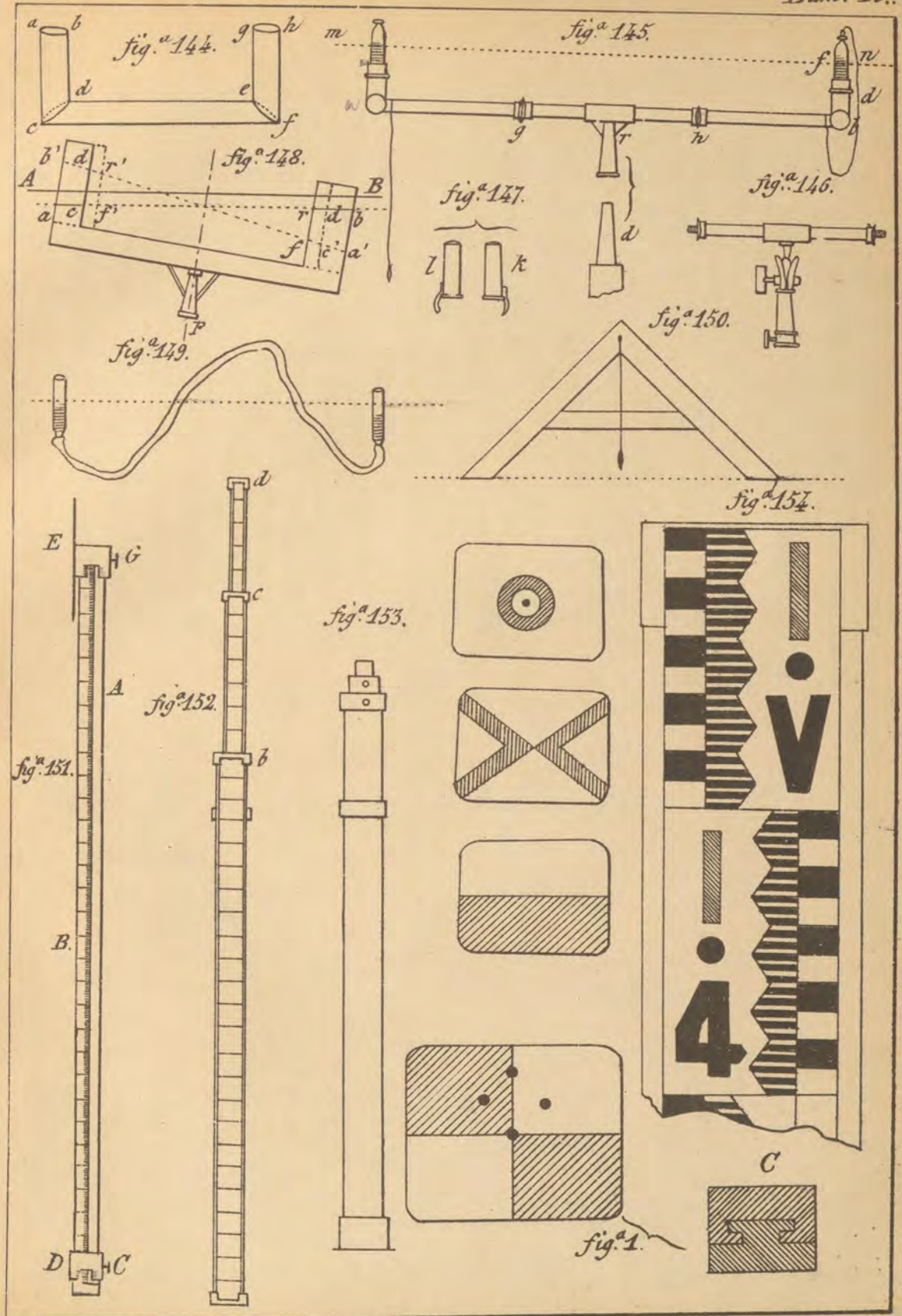
fig. 127.

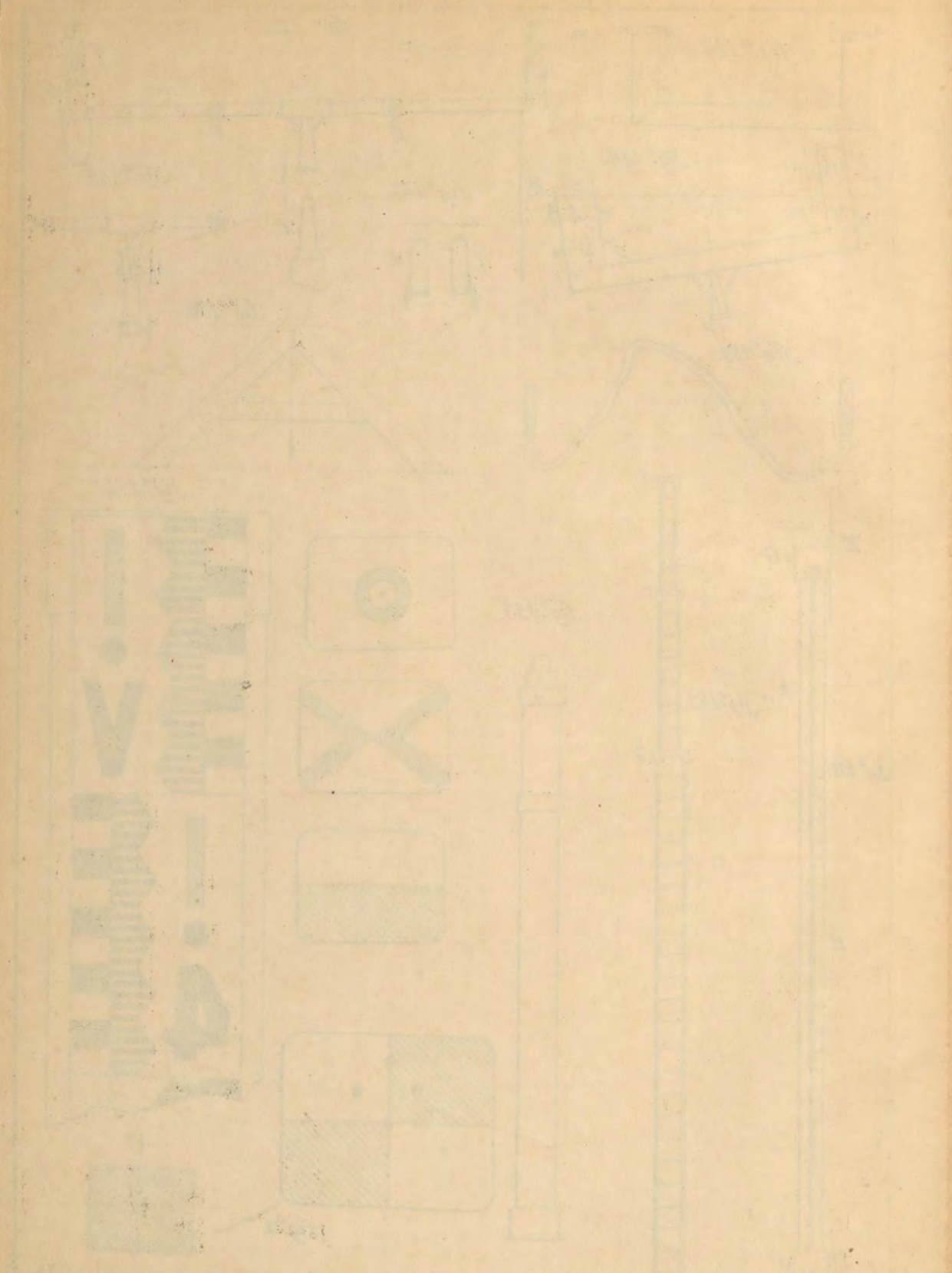


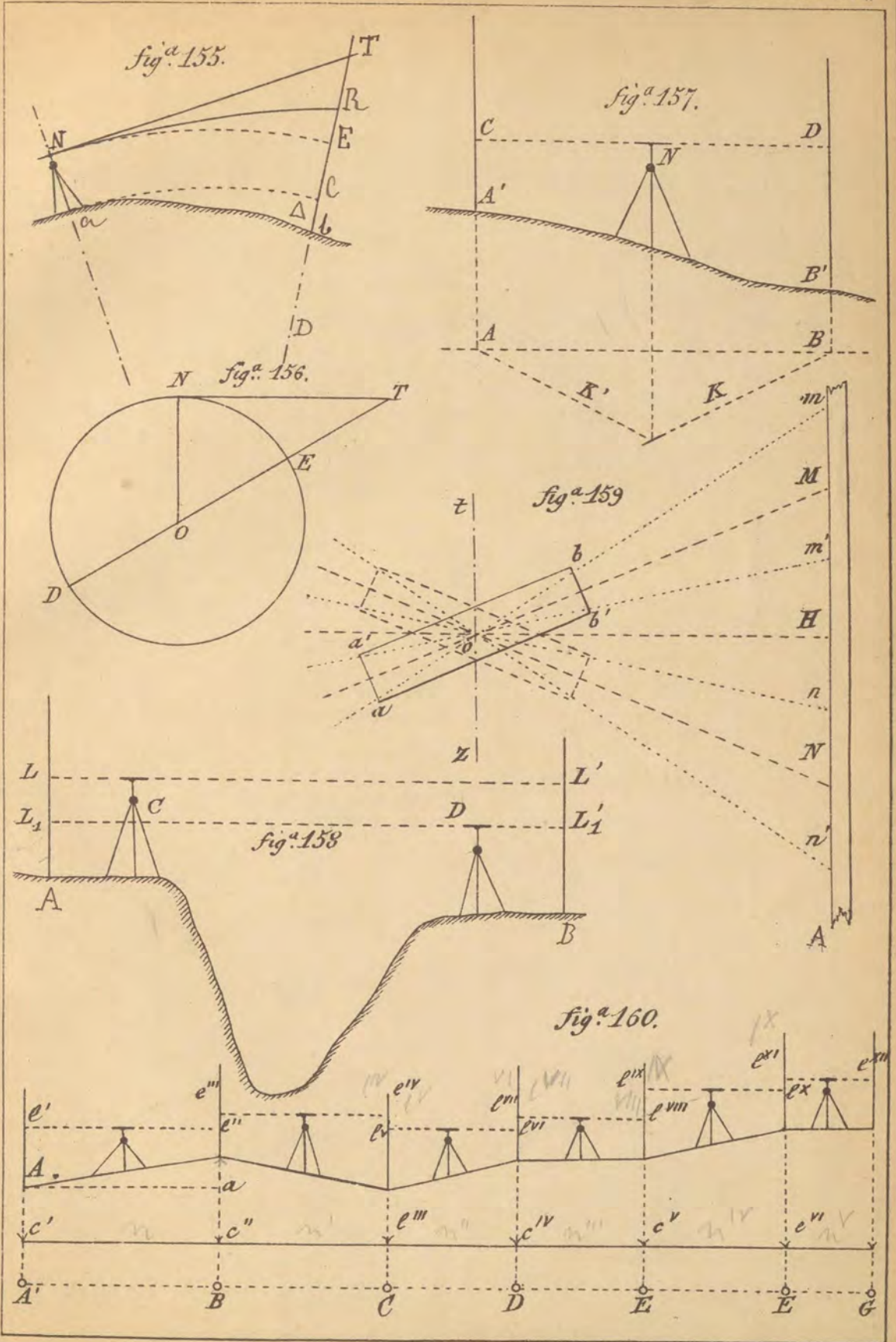


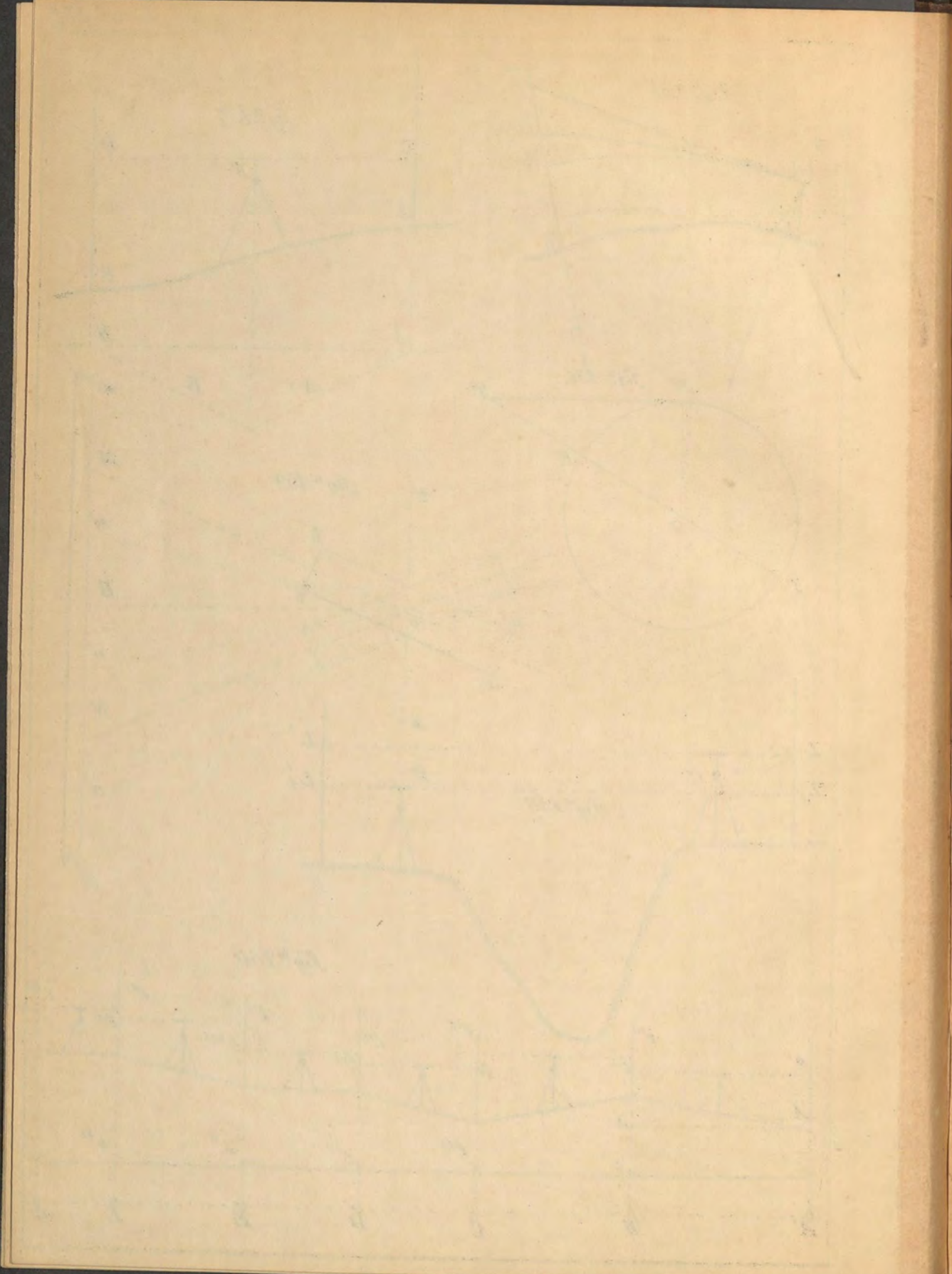












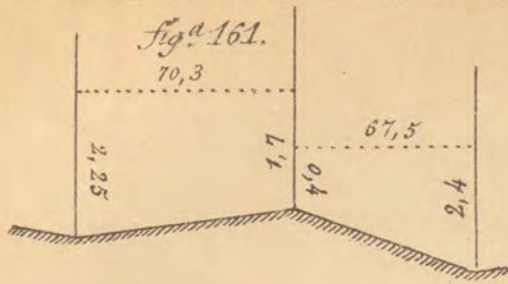


fig.<sup>a</sup> 161.  
70,3

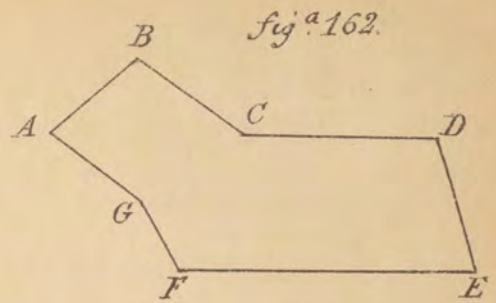


fig.<sup>a</sup> 162.

fig.<sup>a</sup> 163.

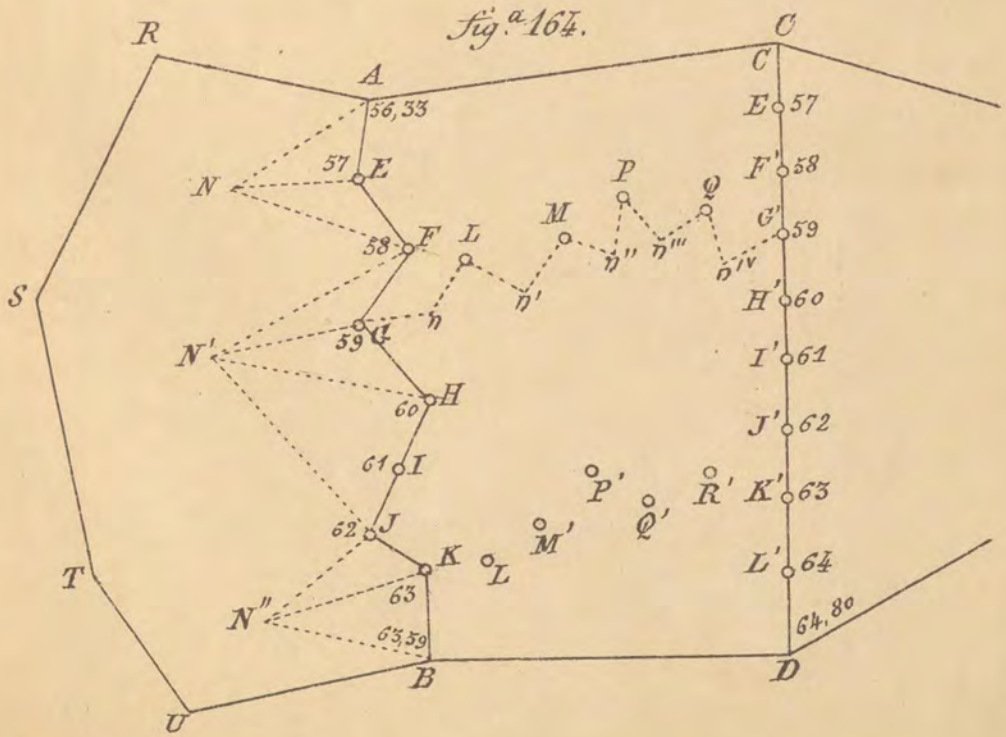
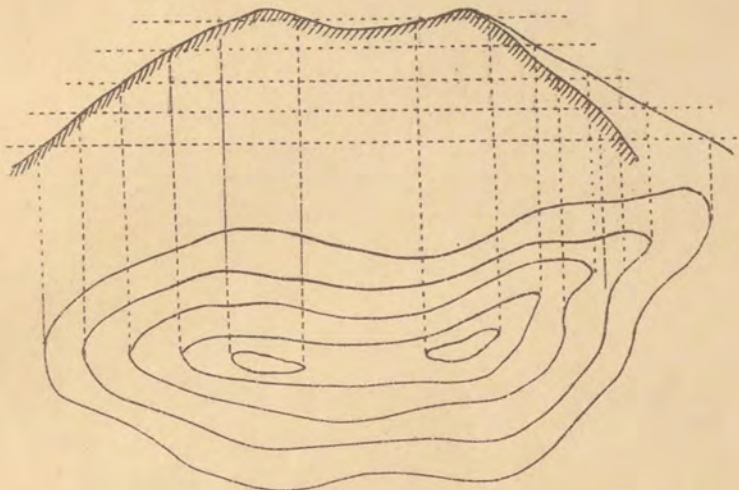
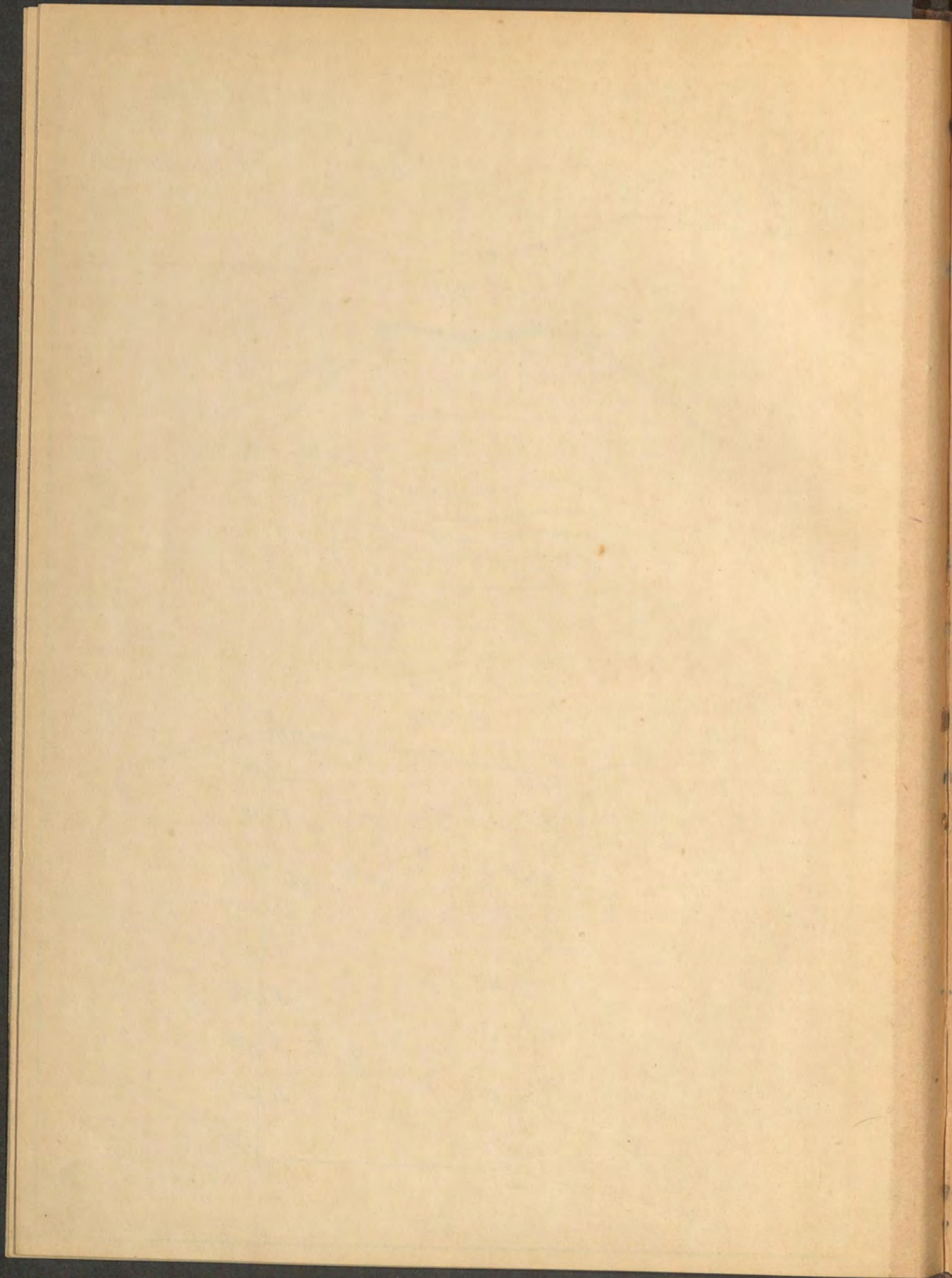
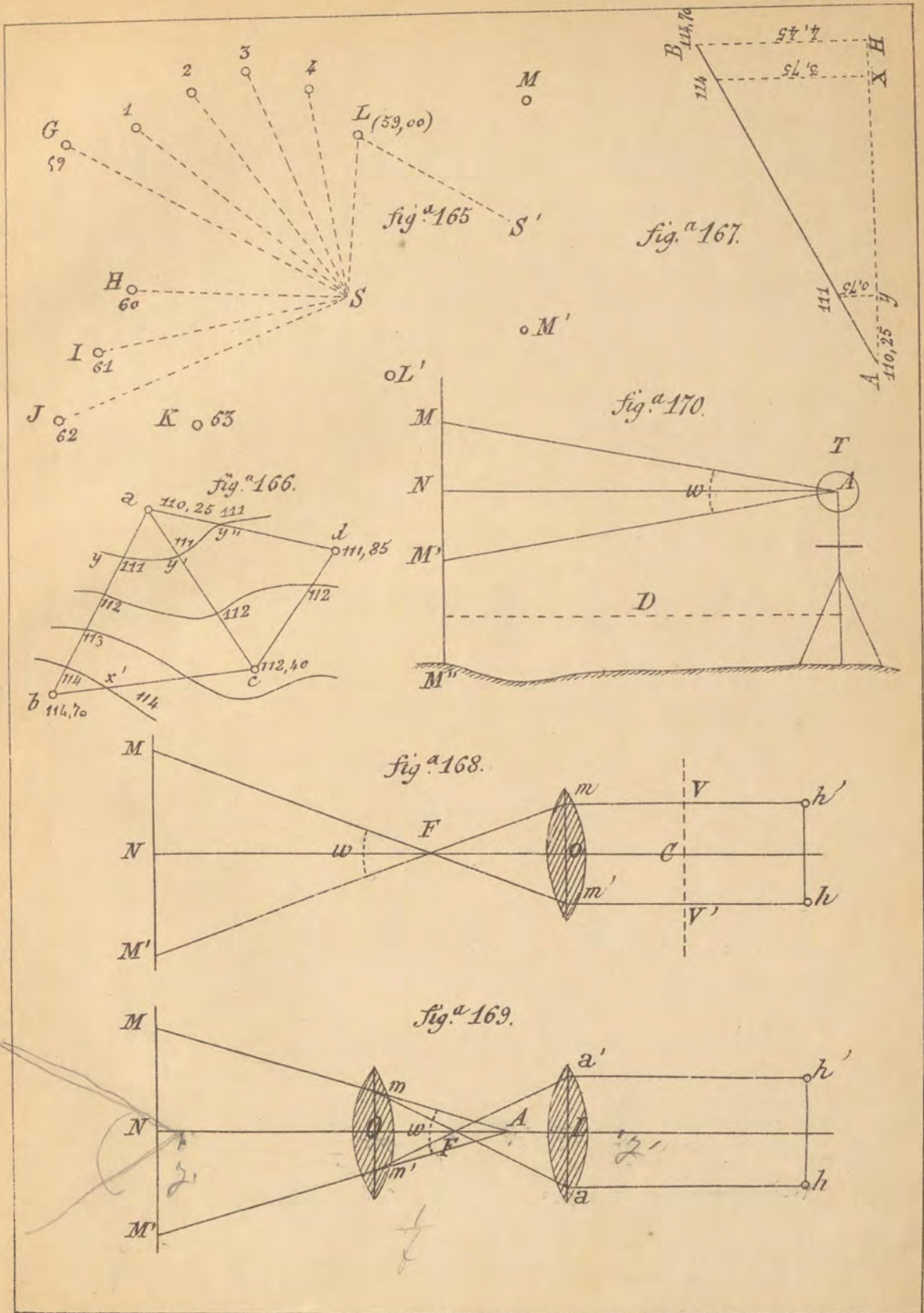
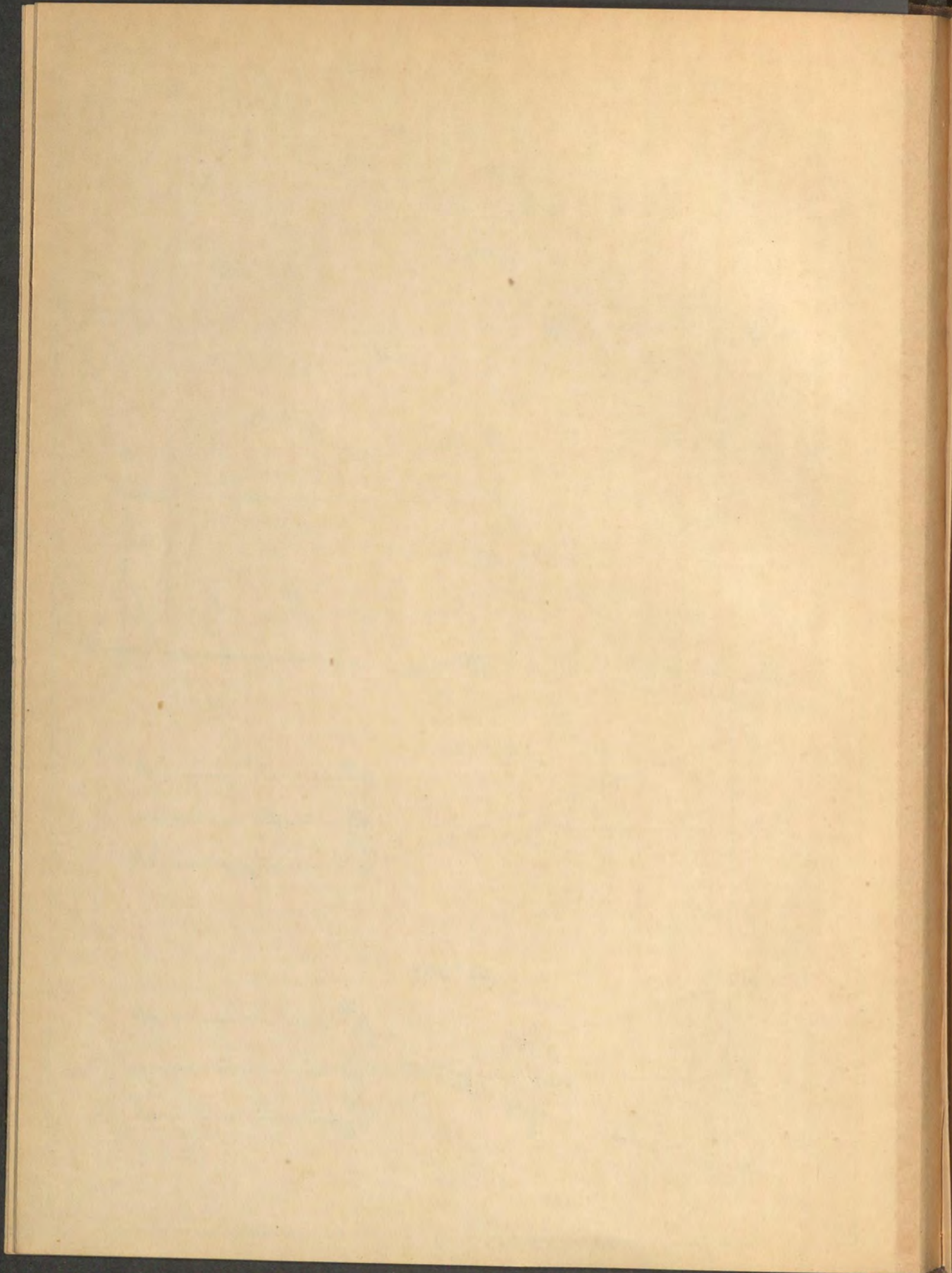


fig.<sup>a</sup> 164.

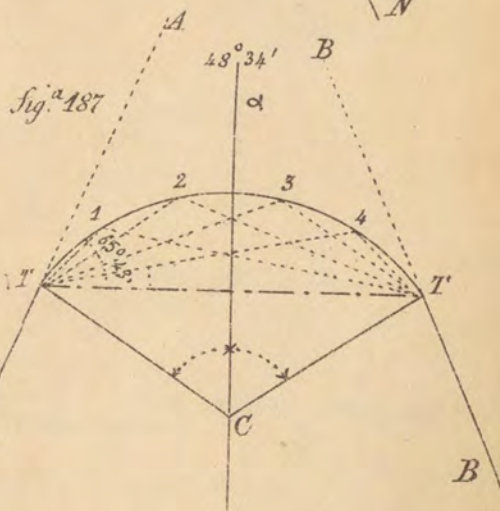
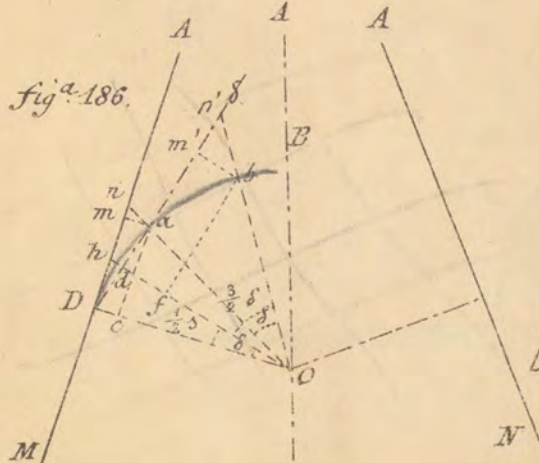
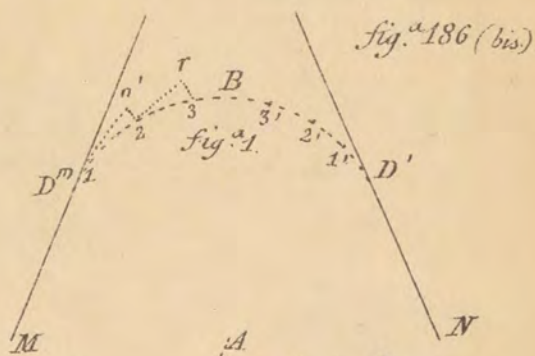
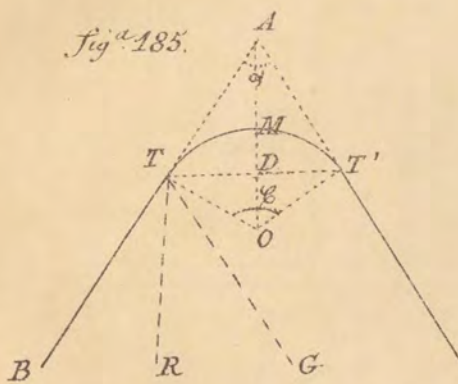
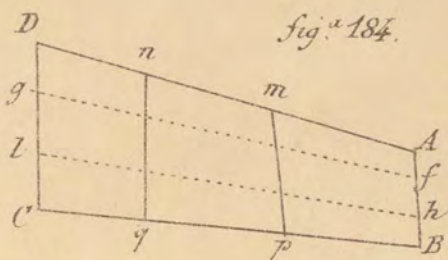
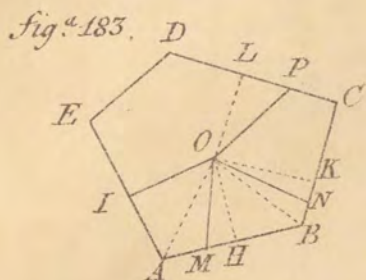
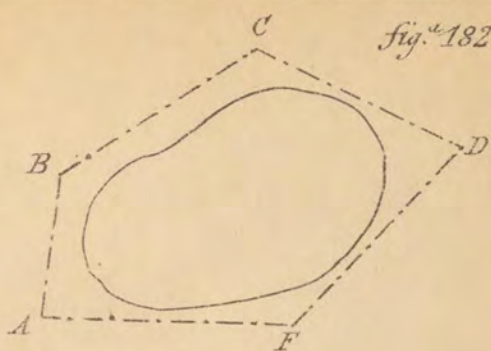
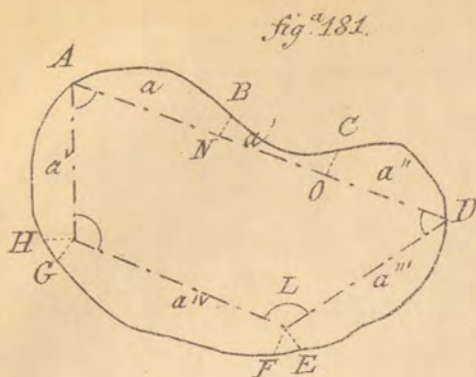


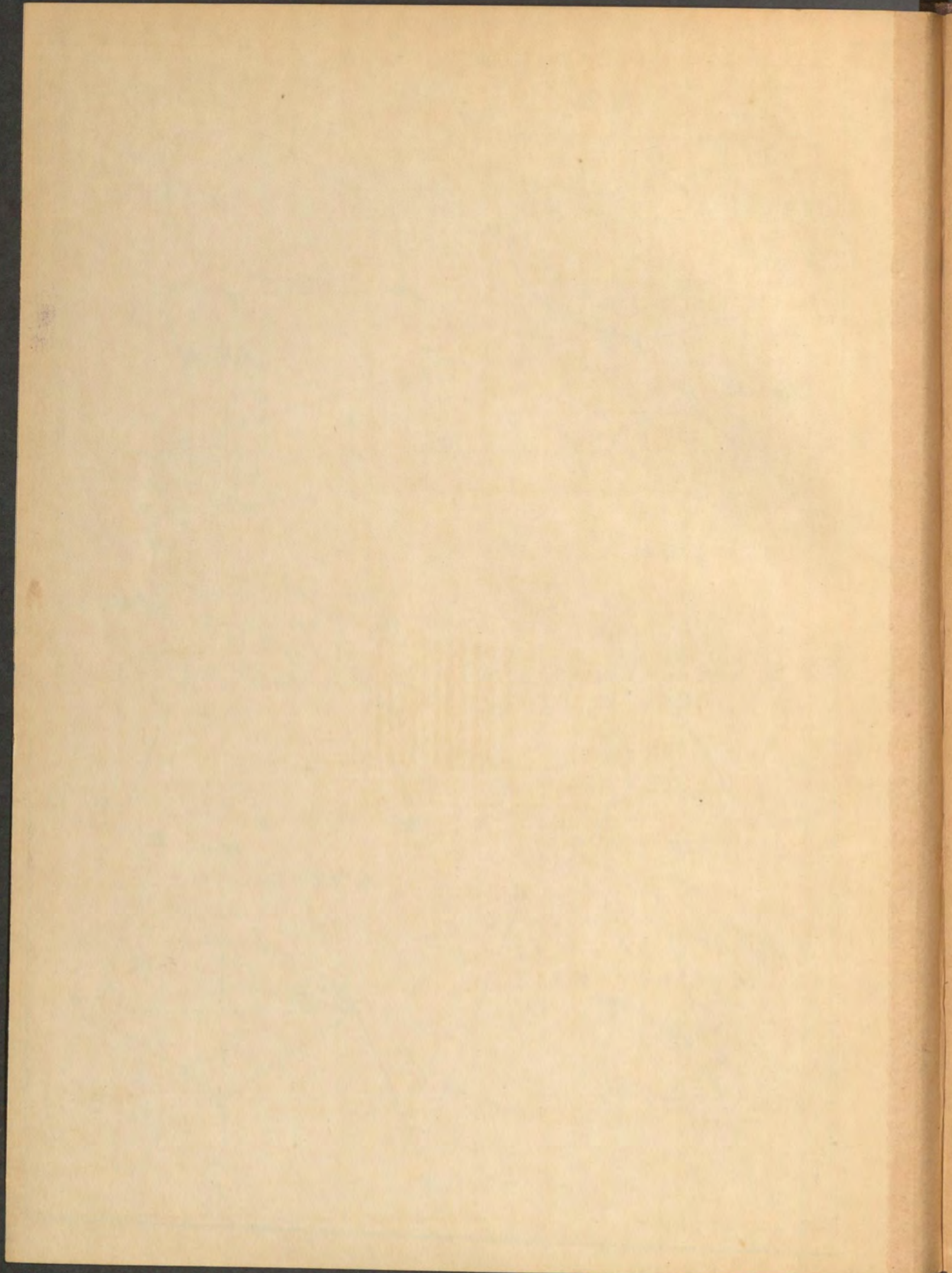


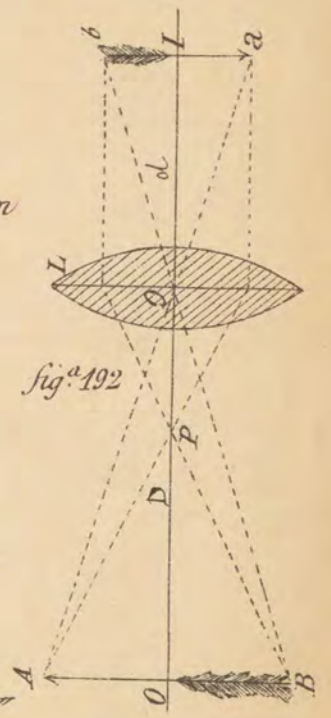
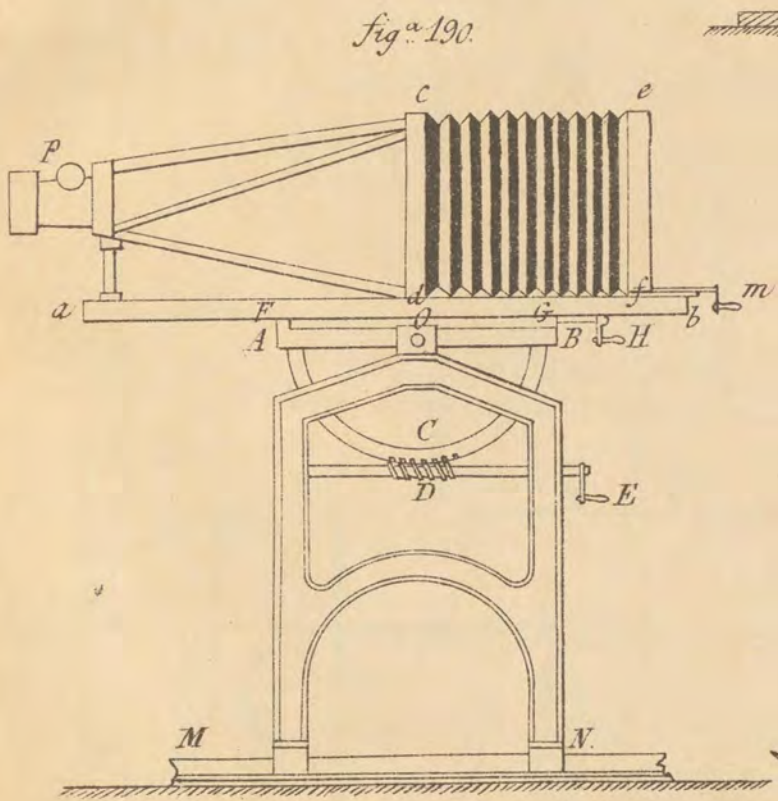
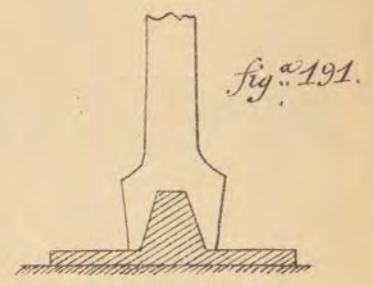
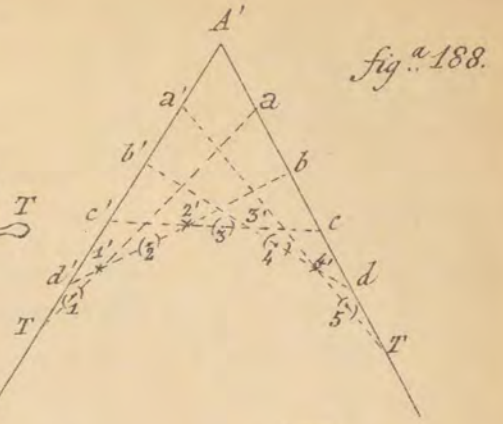
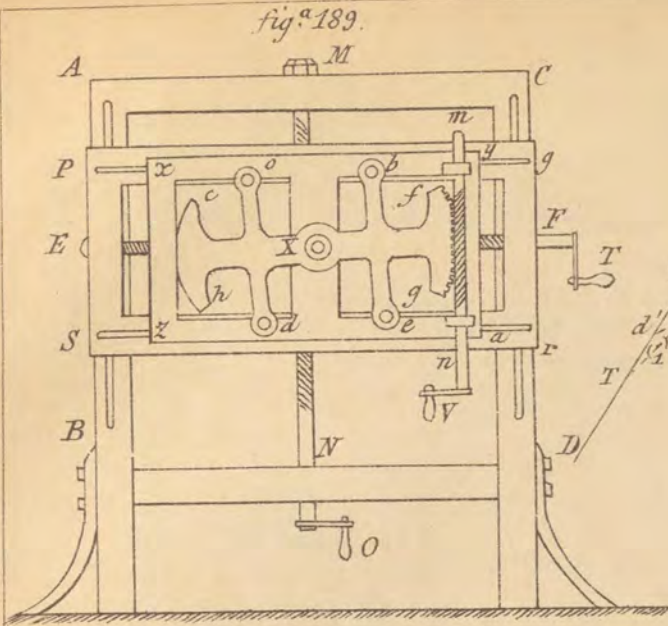


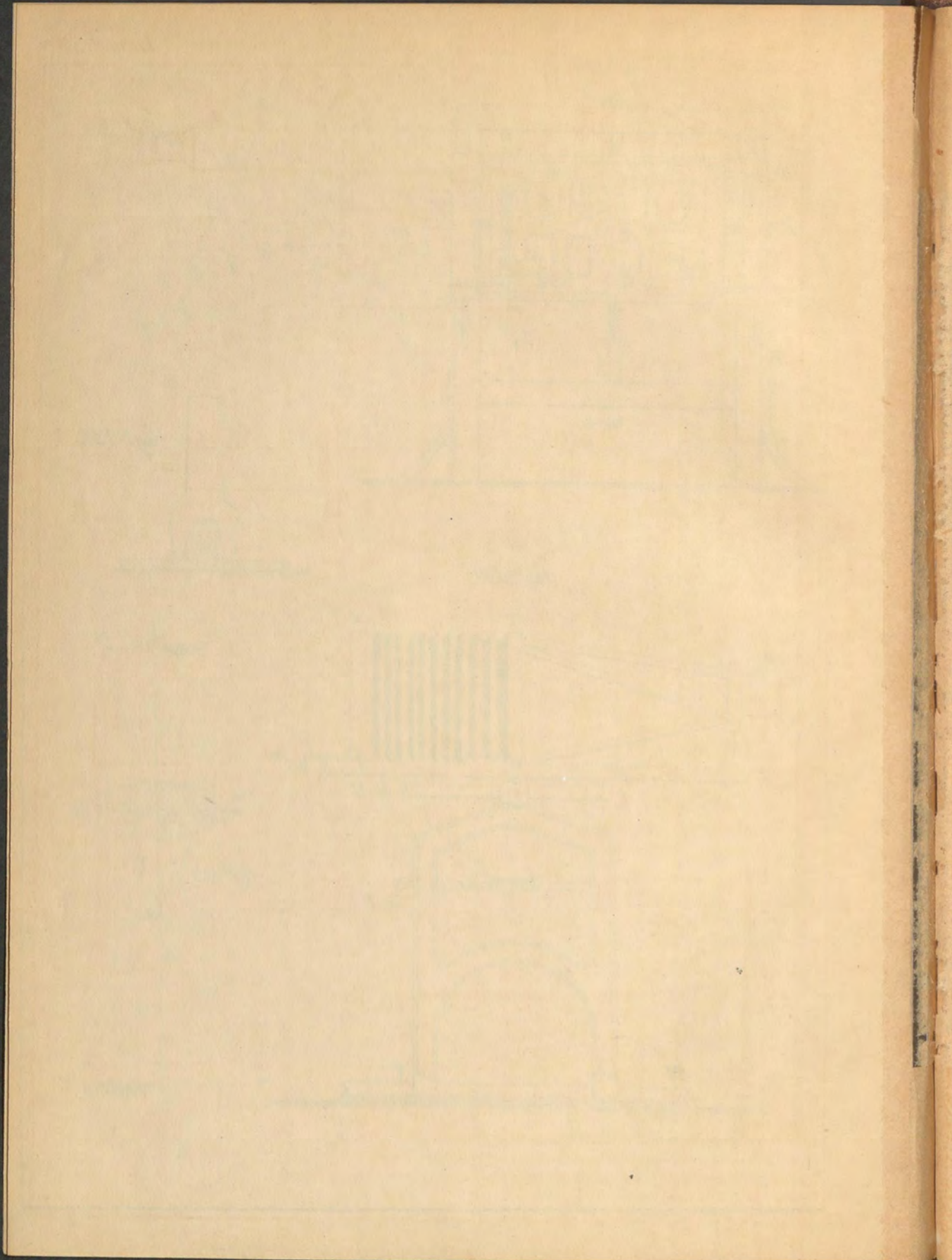


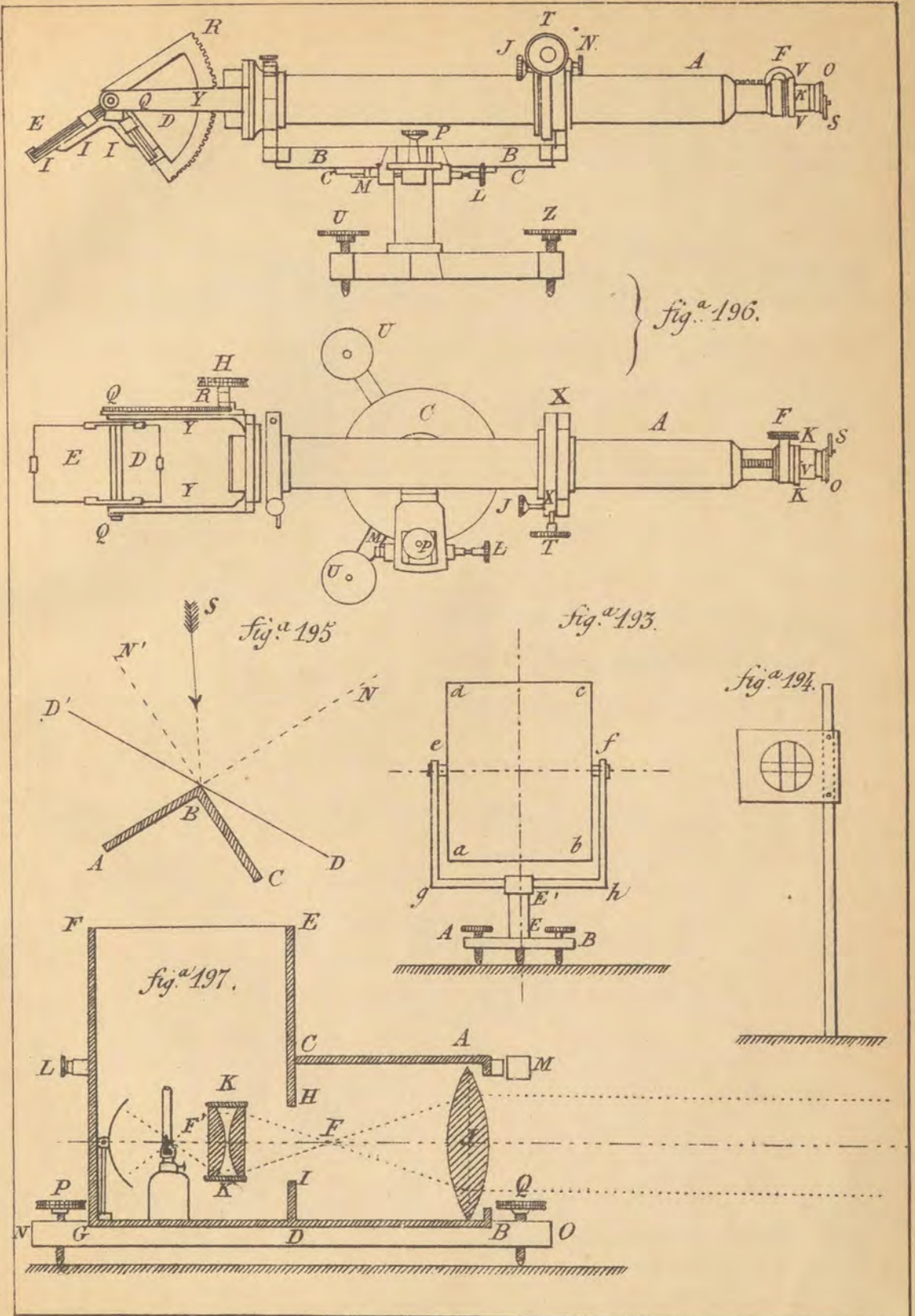


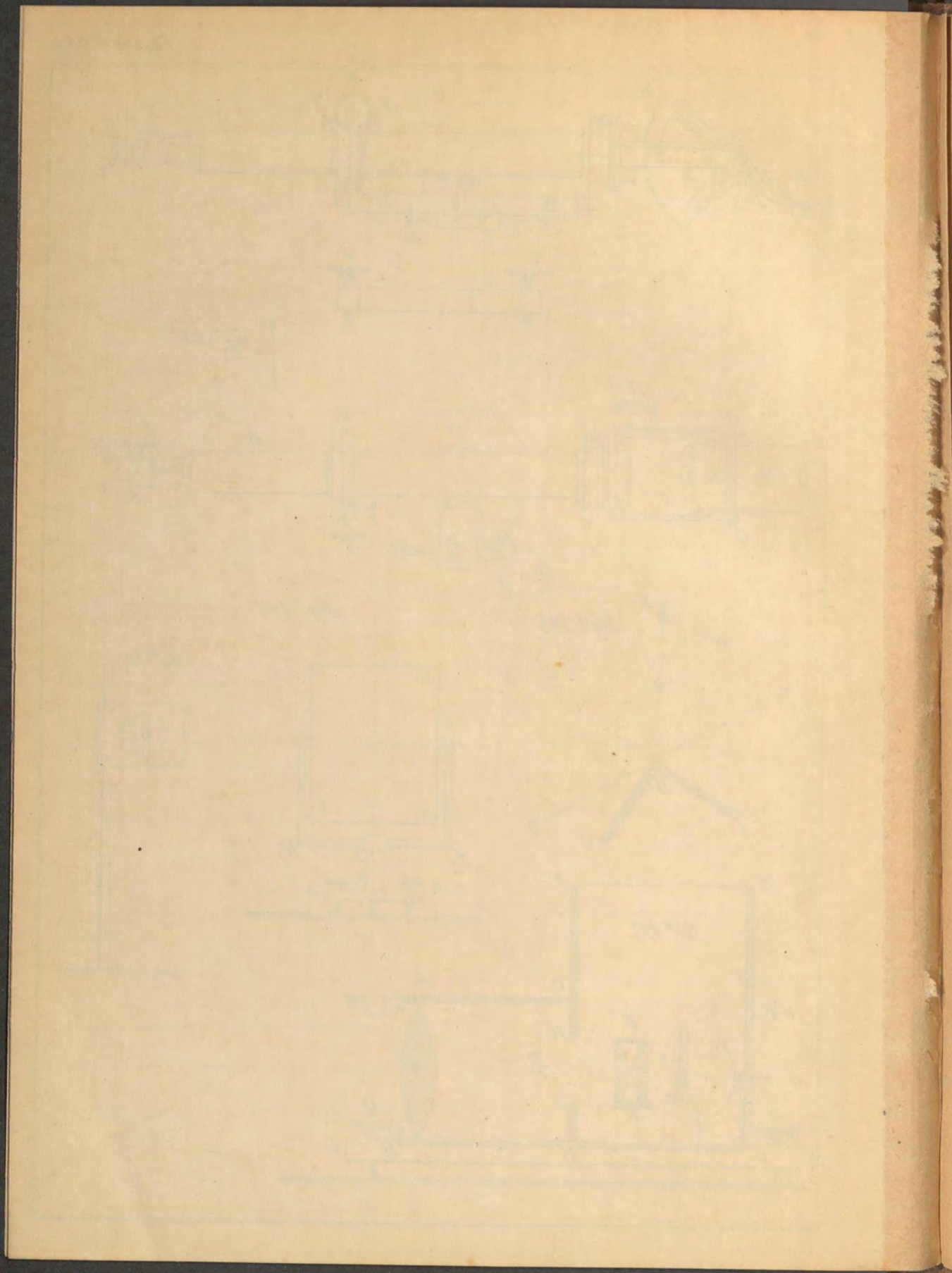












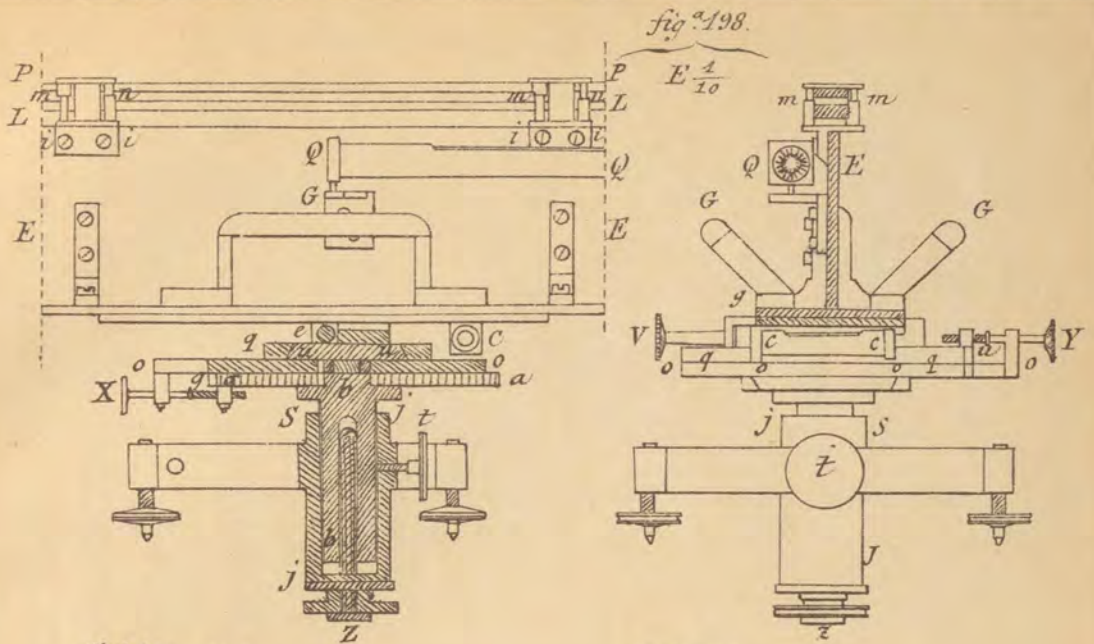


Fig.<sup>a</sup> 199 E  $\frac{1}{2}$

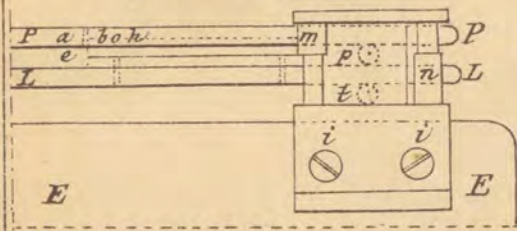
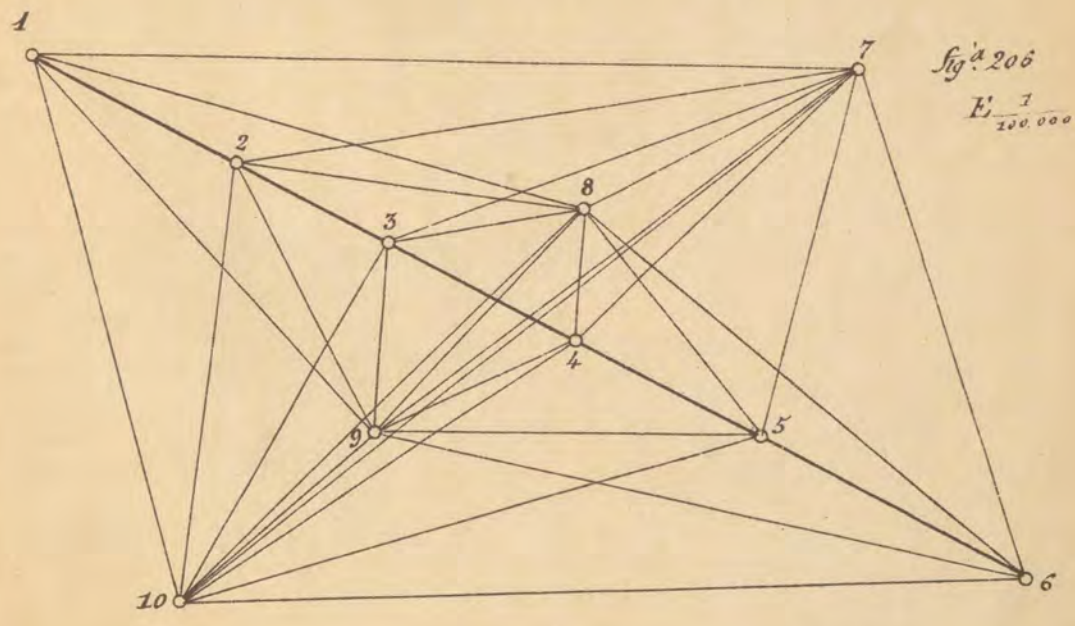
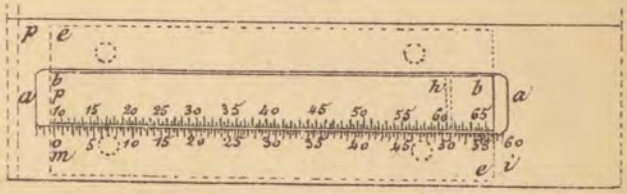


Fig.<sup>a</sup> 200 E  $\frac{1}{4}$



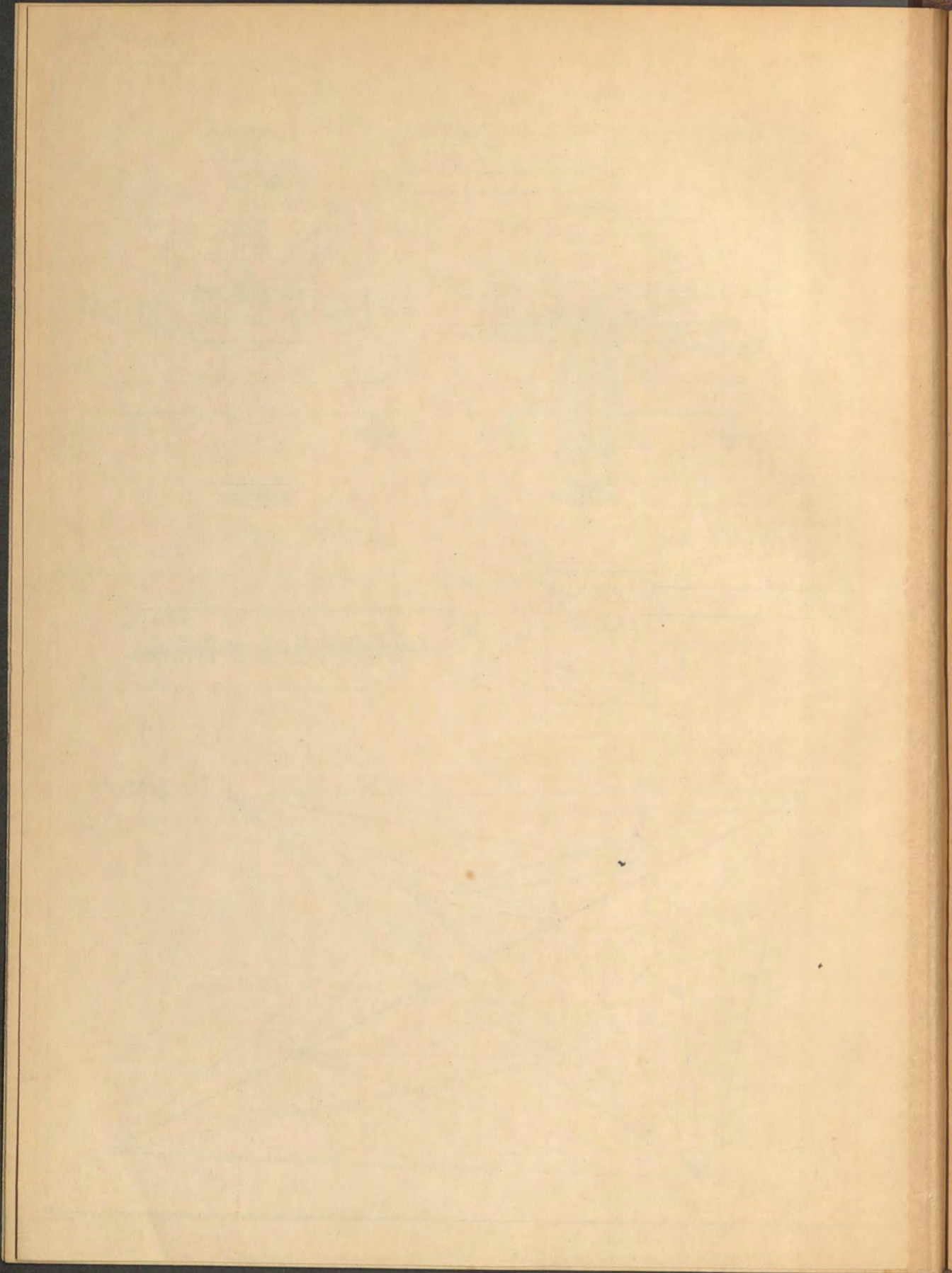






fig.<sup>a</sup> 207.

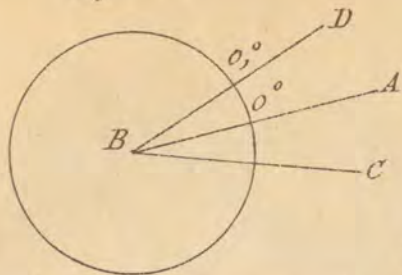


fig.<sup>a</sup> 208.

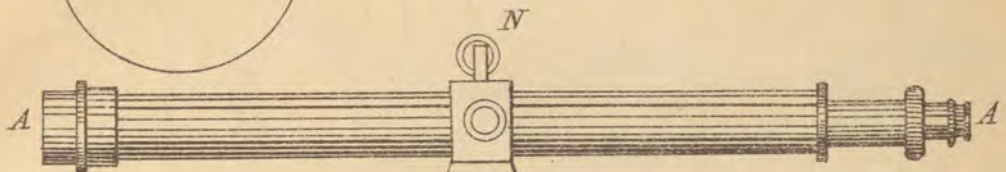
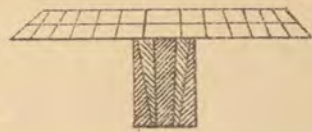


fig.<sup>a</sup> 209.

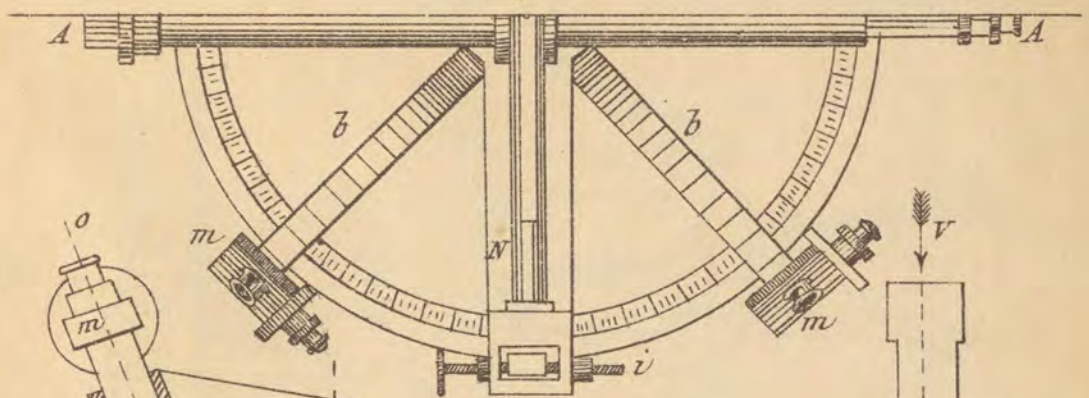
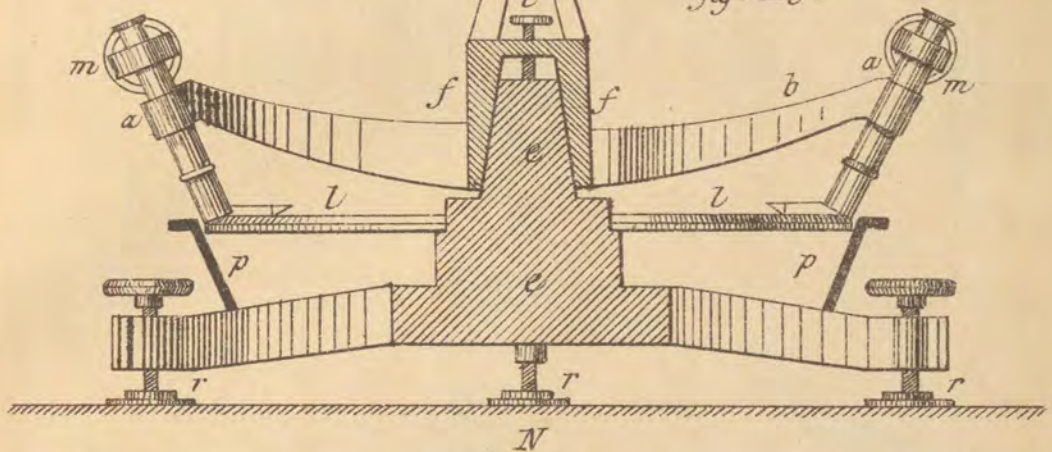


fig.<sup>a</sup> 210

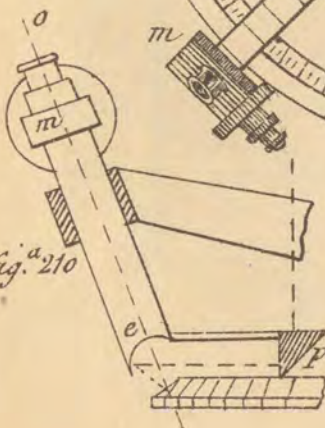
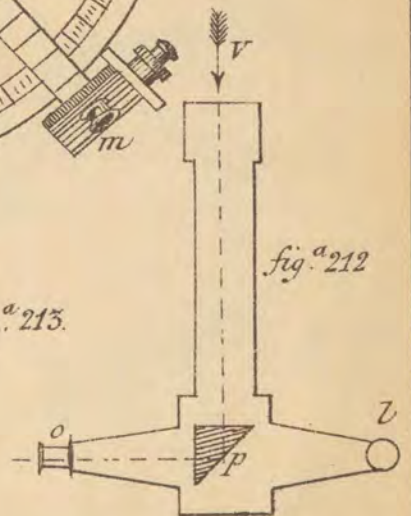


fig.<sup>a</sup> 213.

fig.<sup>a</sup> 212



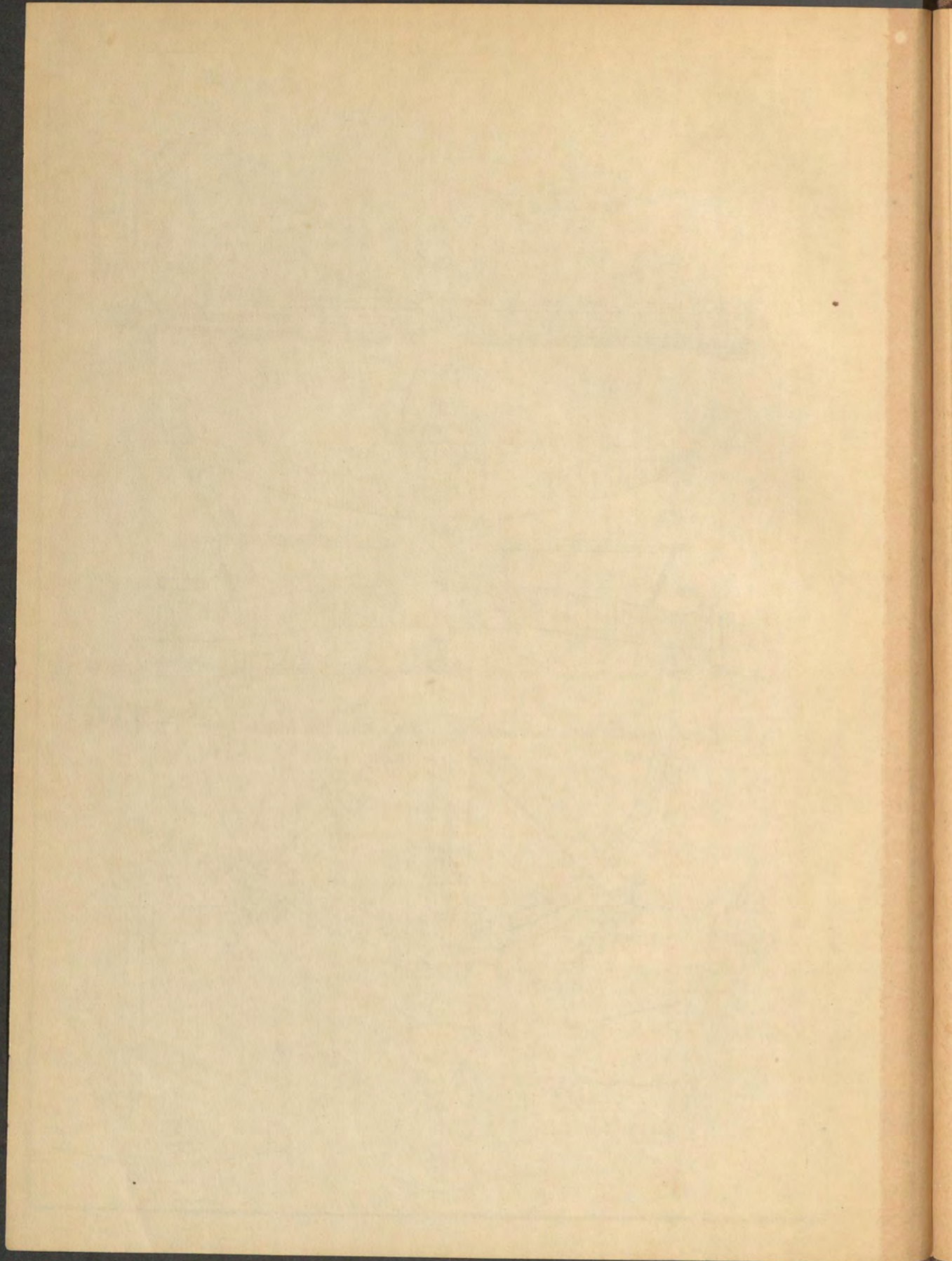


Fig.<sup>a</sup> 211.

Escala  $\frac{1}{5}$ .

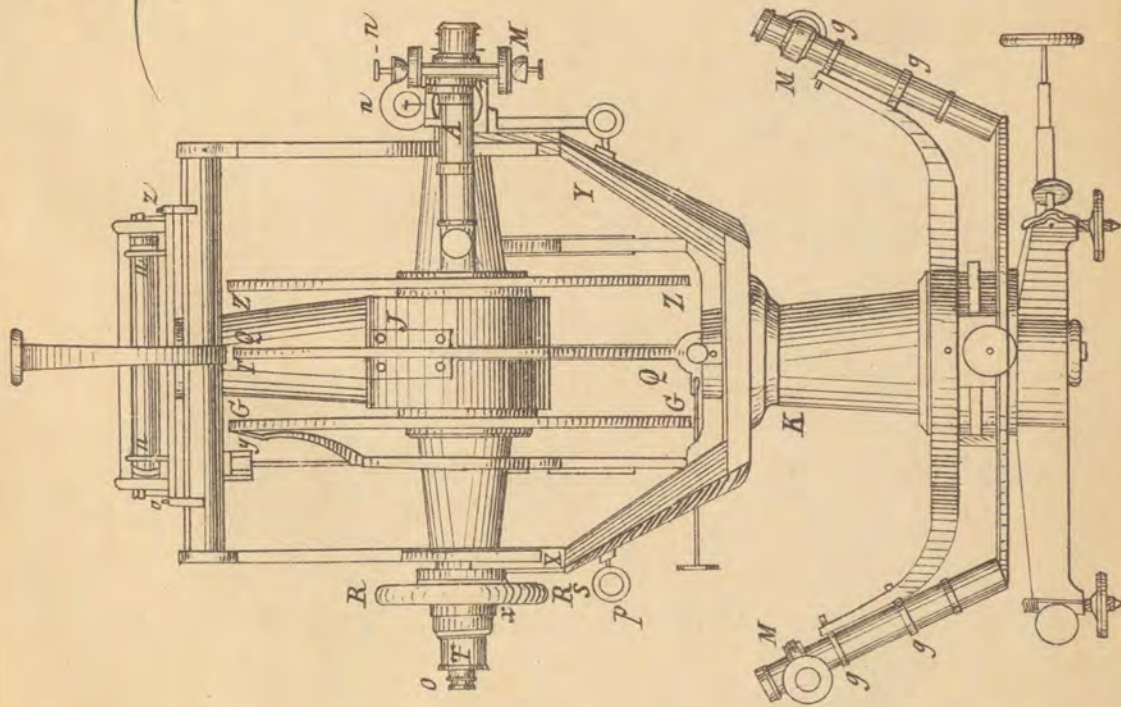
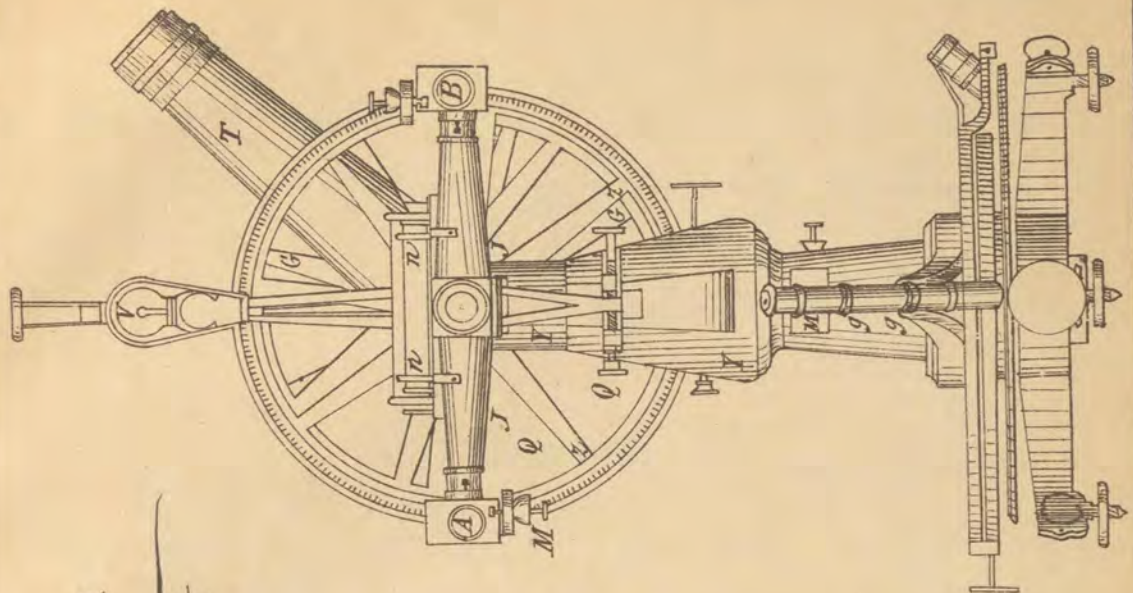
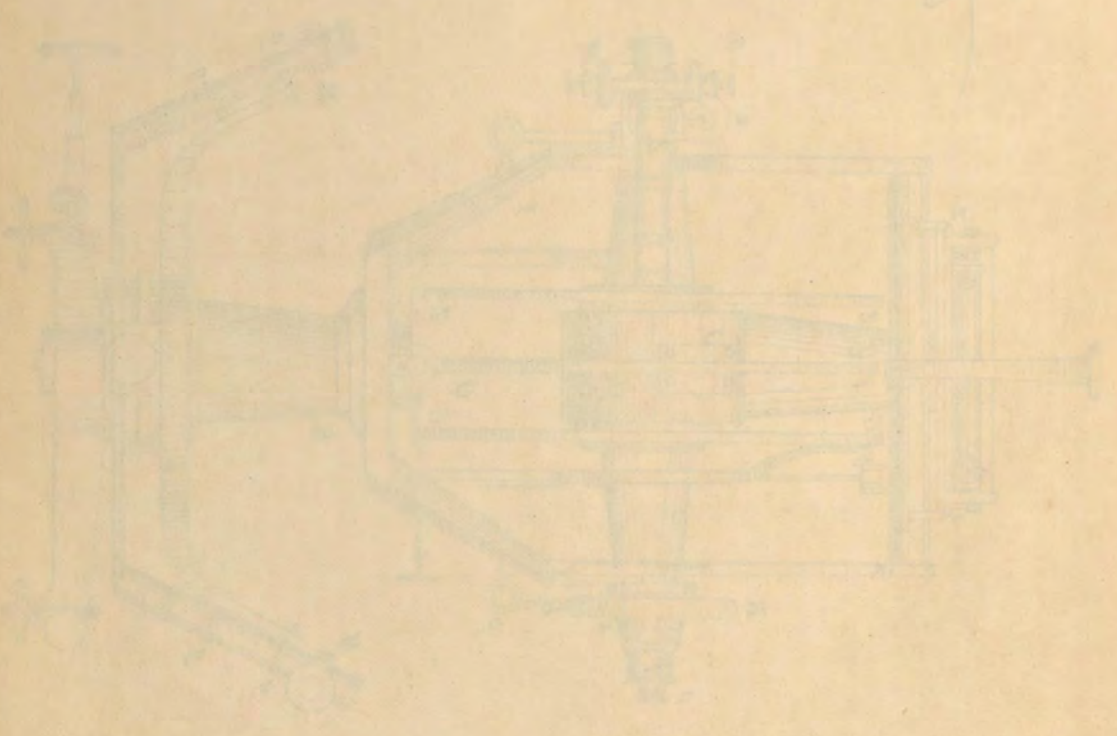
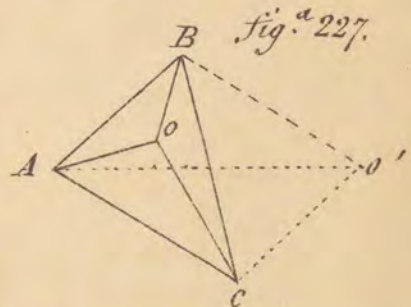
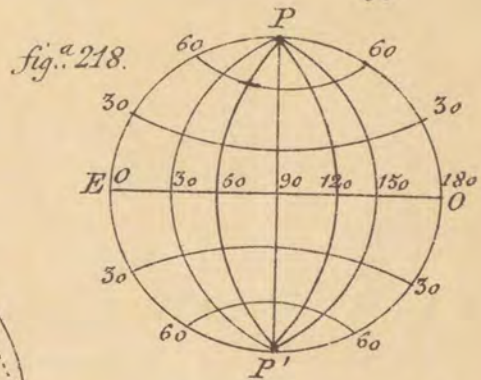
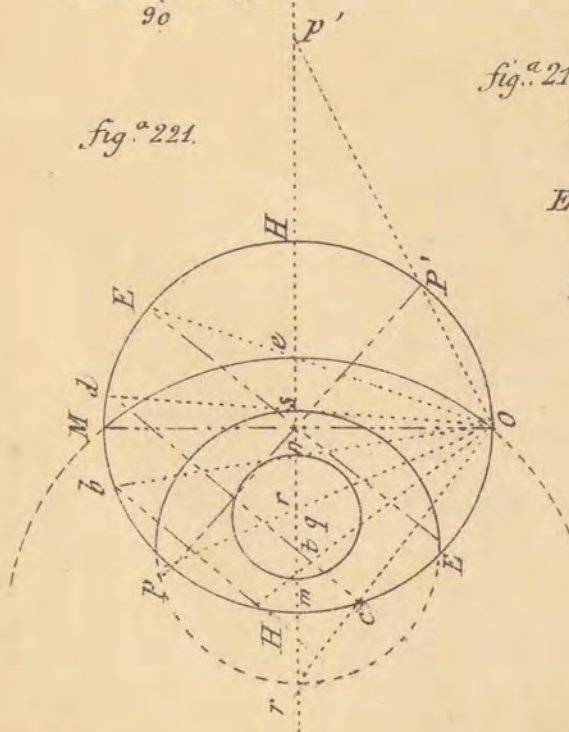
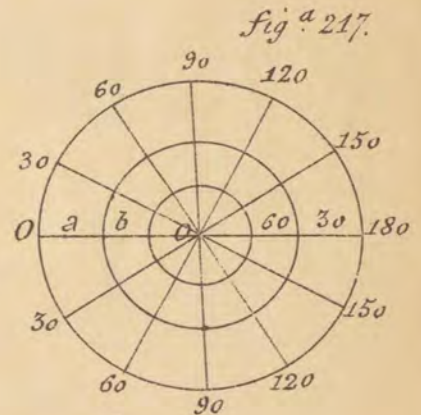
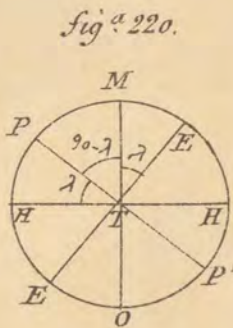
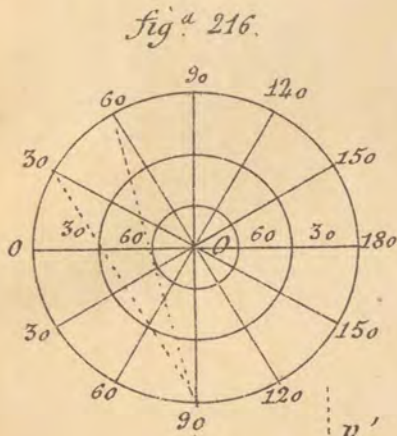
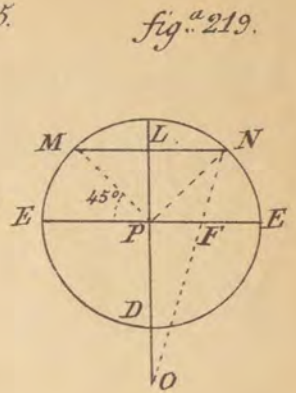
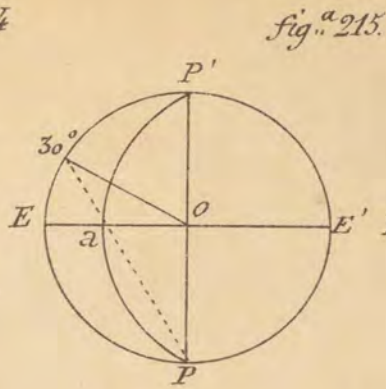
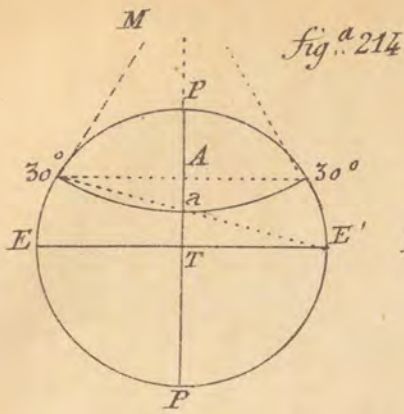




Fig. 111  
1850





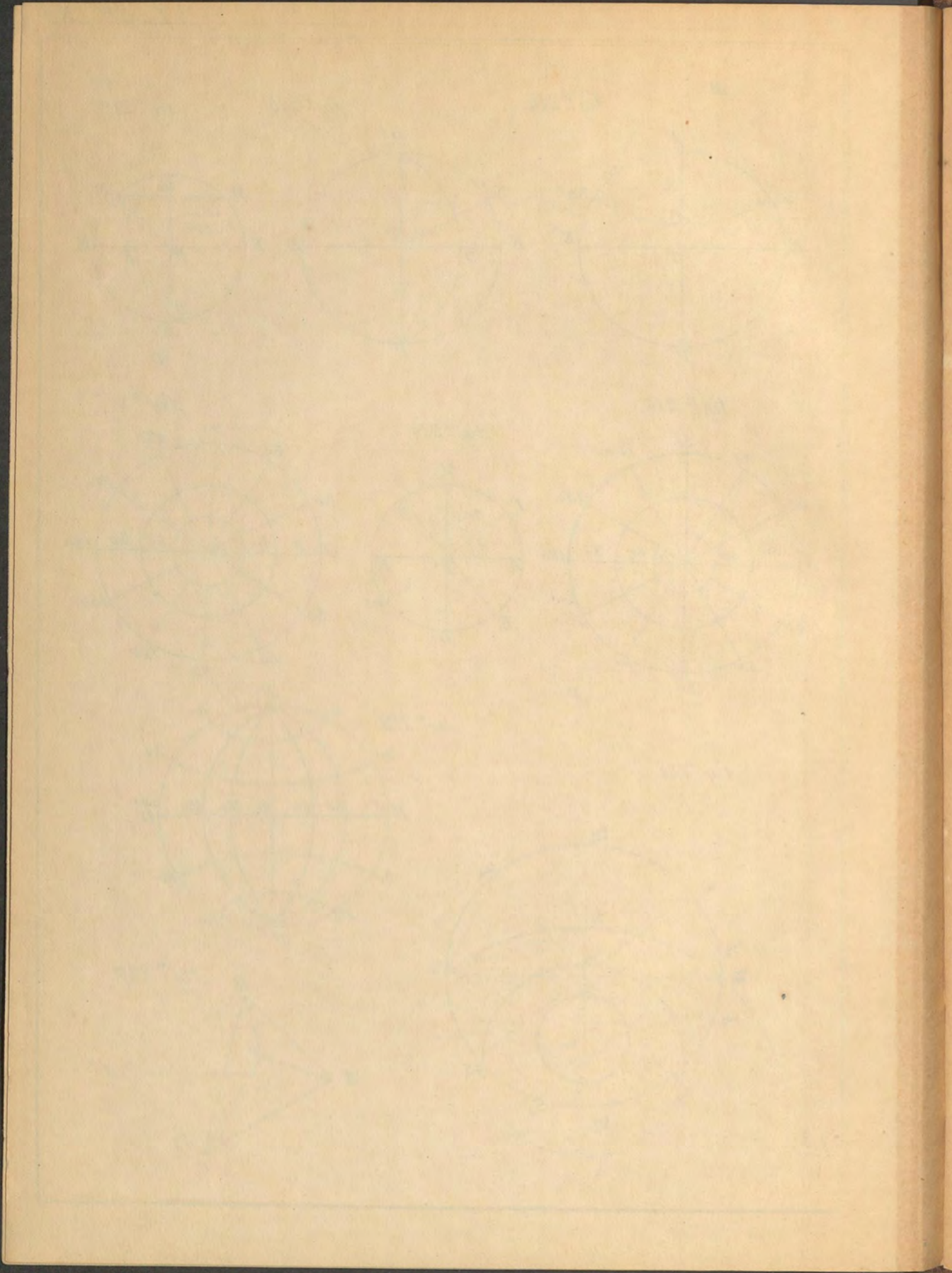


fig.<sup>a</sup> 222.

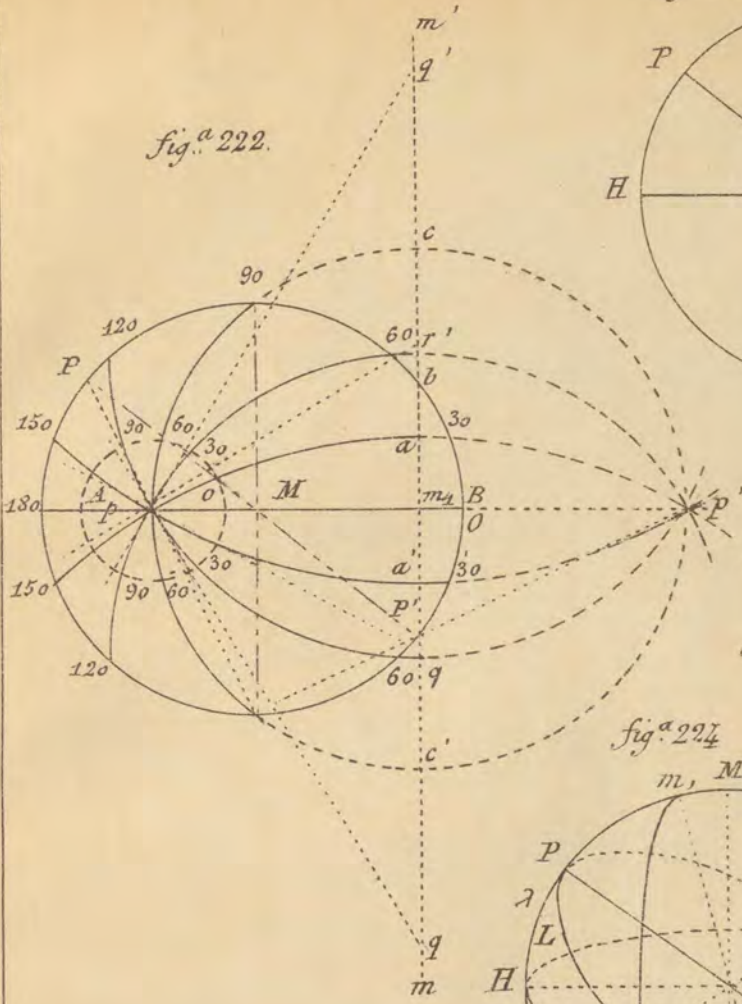


fig.<sup>a</sup> 223.

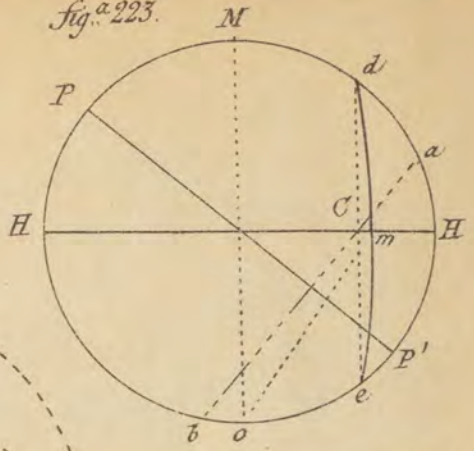


fig.<sup>a</sup> 225.

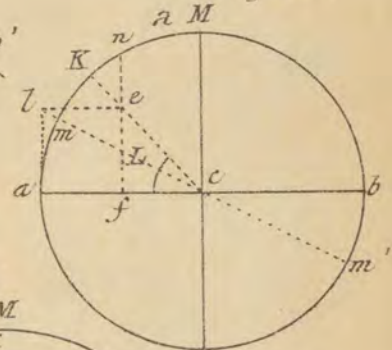


fig.<sup>a</sup> 224.

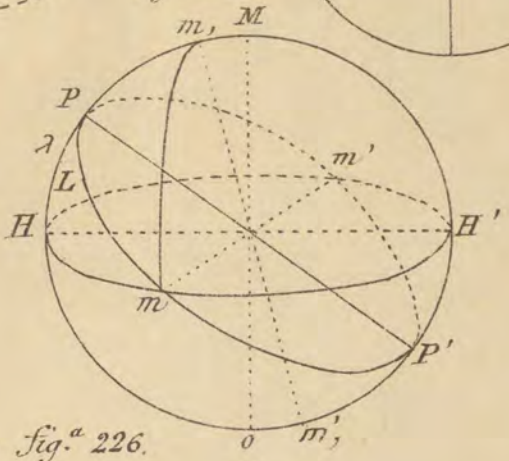


fig.<sup>a</sup> 226.

